

Celebrating **50 Years** of Excellence.

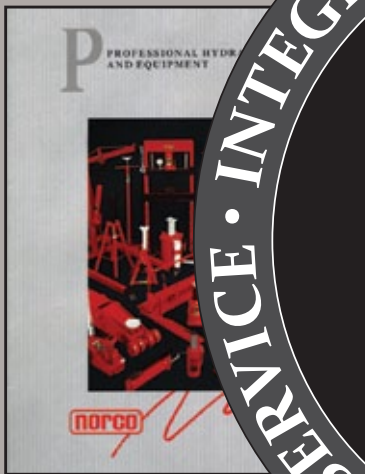
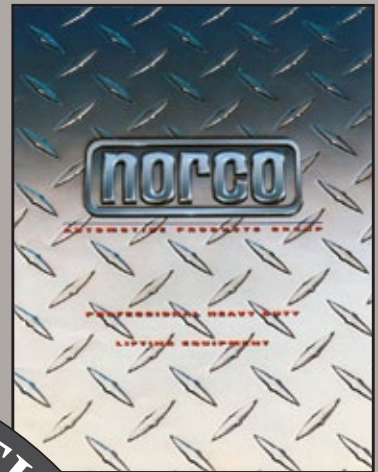
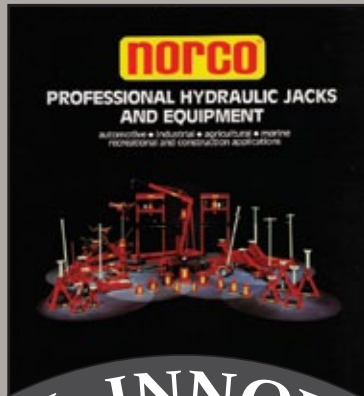
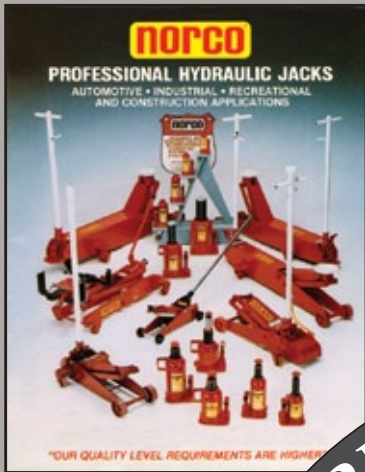

50
YEARS

1964

SERVICE • INTEGRITY • INNOVATION • PERFORMANCE • QUALITY

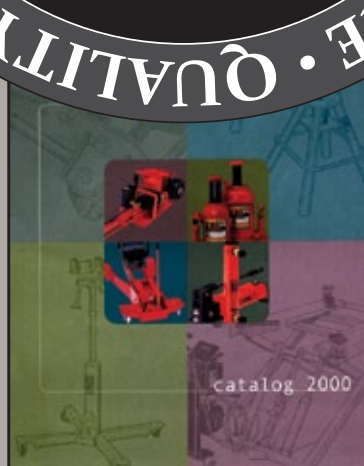
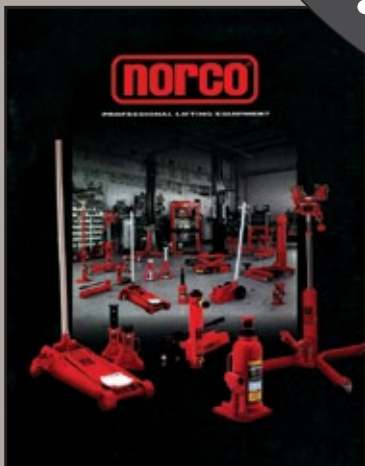
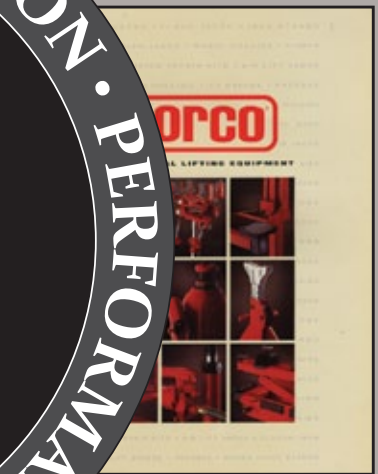

www.norcoindustries.com



NORCO Professional Lifting Equipment brand is proud to announce our **50th Anniversary!**

The Tallmans built NORCO on the principles of providing our customers with quality products that exceed their expectations for performance, safety, and reliability, all at a competitive cost. We know we've been doing the right thing because, after half a century, the NORCO Brand is known around the world. When it comes to product development, "When Safety Depends on Performance" isn't just some tagline, it is our core value.

While we are proud of the products that we provide, we are most proud of the meaningful relationships that we've built along the way. The long-term relationships with our customers, employees, suppliers, and service support network are testimonies to the integrity that is demonstrated by everyone here at NORCO. It has been said, "Time flies when you're having fun." At NORCO not only have we had a lot of fun but we've made a lot of good friends along the way. For that we are most grateful.

From all of us at NORCO, we thank you for your continued loyalty and friendship. We look forward to providing you with another 50 years of quality products and service.



USA Content and ASME / PALD

It is our intent to make as many products in the USA as possible. While we make some products that are 100% "Made in the USA," there are others with less U.S. content. We don't want to mislead the public, so we have come up with a single logo that will cover all of our USA products. When you see our new "U.S. Content" label next to a NORCO product, you can be assured that it has at least 51% USA content as required by the Buy American Act and Federal Acquisition Regulation (FAR).

Here at NORCO, we use the latest ASME/PALD guidelines for product development and testing. It ensures that our products are safe for the user and perform beyond their expectations. And, that's why all of our products, whether import or USA, are confidently covered by the NORCO Limited Lifetime Warranty. (Details on back cover)

Thank you again for the opportunity to offer you the best shop equipment value on the market.

The NORCO Difference:
America's fastest and most durable

norco AIR/HYDRAULIC AXLE JACKS

1



72200D
(22 TON)

FEATURES

- 50" long "T" handle helps in positioning jack under vehicles with low overhang.
- The load release on the top mounted "T" handle allows operation at any handle position.
- Handle locking lever secures handle in either vertical, horizontal or 45 degree position.
- Compact design fits easily between tandem wheels.
- Rust inhibitive coating on ram and extension screw offers longer life.
- Large diameter wheels make maneuverability easy.
- Self-retracting ram eliminates manual lowering of jack.
- Safety by-pass system prevents cylinder damage.
- Safety overload system prevents jack from being used beyond its rated capacity.
- Integrated filter protects air motor.
- Fast lifting air motor.
- Three removable 2" diameter saddles with handle mounted saddle holder; 3/4", 2-1/4" and 4" in height.

72200D
22 TON CAPACITY

INTENDED USE
Ideal for heavy duty truck, agricultural and heavy construction equipment.

72203
2-1/4" Extension Adapter Saddle

72204
4" Extension Adapter Saddle



72205

SADDLE ADAPTER KIT
Includes handle mounted saddle holder two adapters.
Weight: 10 lbs.



| MODEL NUMBER | CAPACITY | LIFT HEIGHT | | STROKE | SCREW EXTENSION | OVERALL DIMENSIONS | | P.S.I. RANGE | SHIPPING WEIGHT |
|---------------|---------------|-------------|------|--------|-----------------|--------------------|-------|--------------|-----------------|
| | | Low | High | | | Length | Width | | |
| 72200D | 22 Ton | 9" | 18" | 4.75" | 4.25" | 20" | 13" | 85-200 | 115 lbs. |

The NORCO Difference:
Its light weight makes it perfect for mobile repair service

norco AIR/HYDRAULIC AXLE JACKS

FEATURES

- Long handle with 36-1/2" reach helps in positioning jack under vehicles with low overhang.
- May be stored in a vertical position.
- Hand grip also works as a stand to store the jack in a vertical position.
- Compact design fits easily between tandem wheels.
- Parkerized coating on pump piston, extension screw and extension adapters and chrome coated ram offer protection against rust.
- Removable extension screw is used with the two 4" extension adapters (included) for added height when necessary.
- Self-retracting ram eliminates manual lowering of the jack.
- 5-1/4" diameter high impact composite wheels make maneuverability easy.
- Fast efficient air pump reduces lifting time and has a built-in relief mechanism which prevents the jack from being used beyond its maximum capacity.
- Convenient push button air valve connected to an in-line filter prohibits contaminants from entering the air/hydraulic system.



***72080A**
72090A (shown)

***NOTE:**
Models not shown have same basic construction as models pictured.

72080A

STANDARD HEIGHT
20 TON CAPACITY

72090A

LOW HEIGHT
20 TON CAPACITY

INTENDED USE
Heavy duty truck, agricultural and heavy construction equipment. Ideal for loaded truck and trailer roadside service calls.



| MODEL NUMBER | CAPACITY | LIFT HEIGHT | | STROKE | SCREW EXTENSION | BASE SIZE | P.S.I. RANGE | SHIPPING WEIGHT |
|---------------|---------------|-------------|---------|--------|-----------------|----------------|--------------|-----------------|
| | | Low | High | | | | | |
| 72080A | 20 Ton | 11.125" | 28.625" | 6.625" | 2.75" | 9.25" x 17.25" | 100-130 | 70 lbs. |
| 72090A | 20 Ton | 8.625" | 22.75" | 4" | 2.75" | 9.25" x 17.25" | 100-130 | 63 lbs. |

72212

55 / 37 / 23 / 12
TON CAPACITY

72218

33 / 20
TON CAPACITY

72225

50 / 25
TON CAPACITY

INTENDED USE

Heavy duty truck, rail, bus,
agriculture and construction
equipment applications.

FEATURES

- Long "T" handle helps in positioning jack under vehicles with low overhang.
- Handle locking lever secures handle in either vertical, horizontal or 45 degree position.
- Safety overload system prevents cylinder damage.
- Rust inhibitive coating on rams offers longer life.
- Integrated filter protects air motor.
- Double acting pump raises ram more quickly to the load.
- Suspension loaded axle prevents wheel damage.
- Vacuum operated ram retraction eliminates manual lowering of jack.
- Safety button at the top of the handle can be pushed in to immediately stop the jack operation in case of emergency.
- Models 72212 and 72225 include a removable 2-3/4" diameter saddle, 2-9/16" and 5-7/8" long extensions with extension holder. Model 72218 includes 2" and 3-15/16" stackable extensions with extension holder.
- Model 72244 includes a removable 2-3/4" diameter saddle, 2" and 4" long stackable extensions and extension holder.

72244

44 TON CAPACITY

INTENDED USE

Heavy duty truck, agricultural and
heavy construction equipment.
Ideal for loaded truck and trailer
roadside service calls. Heavy enough
for rail and bus work.



72218
(2 stage)

72212
(4 stage)

72225
(2 stage)

72244
(44 TON)

wheels
concealed

| MODEL NUMBER | CAPACITY (TONS) @ LIFTING STAGE | | | | LIFT HEIGHT | | OVERALL DIMENSIONS | | PISTON STROKE | HANDLE LENGTH | P.S.I. RANGE | SHIPPING WEIGHT |
|--------------|---------------------------------|----|----|----|-------------|---------|--------------------|--------|---------------|---------------|--------------|-----------------|
| | 1 | 2 | 3 | 4 | Low | High | Length | Width | | | | |
| 72212 | 55 | 37 | 23 | 12 | 6" | 15.375" | 39.25" | 8.625" | 9.5" | 61.75" | 100-175 | 233 lbs. |
| 72218 | 33 | 20 | -- | -- | 6" | 12" | 16" | 6.75" | 6.125" | 49.25" | 120-175 | 100 lbs. |
| 72225 | 50 | 25 | -- | -- | 8.75" | 16.5" | 39.25" | 8.625" | 7.875" | 61.75" | 120-175 | 235 lbs. |
| 72244 | 44 | -- | -- | -- | 9.25" | 15.625" | 21.625" | 8.125" | 5.5" | 61.75" | 130-175 | 149 lbs. |



The NORCO Difference:

Highest 5 ton lift height on the market

FEATURES

- Chromed ram and dust seals prevent hydraulic contamination.
- Safety by-pass and overload systems protect hydraulic block.
- Air pump models can also be operated manually.
- All models except for the 72230A include the FASTJACK® feature which raises the jack's lifting saddle to the load with one pump of the "T" handle.
- Locking release lever secures handle in the vertical, 45 degree or horizontal position to lower the load on all models.

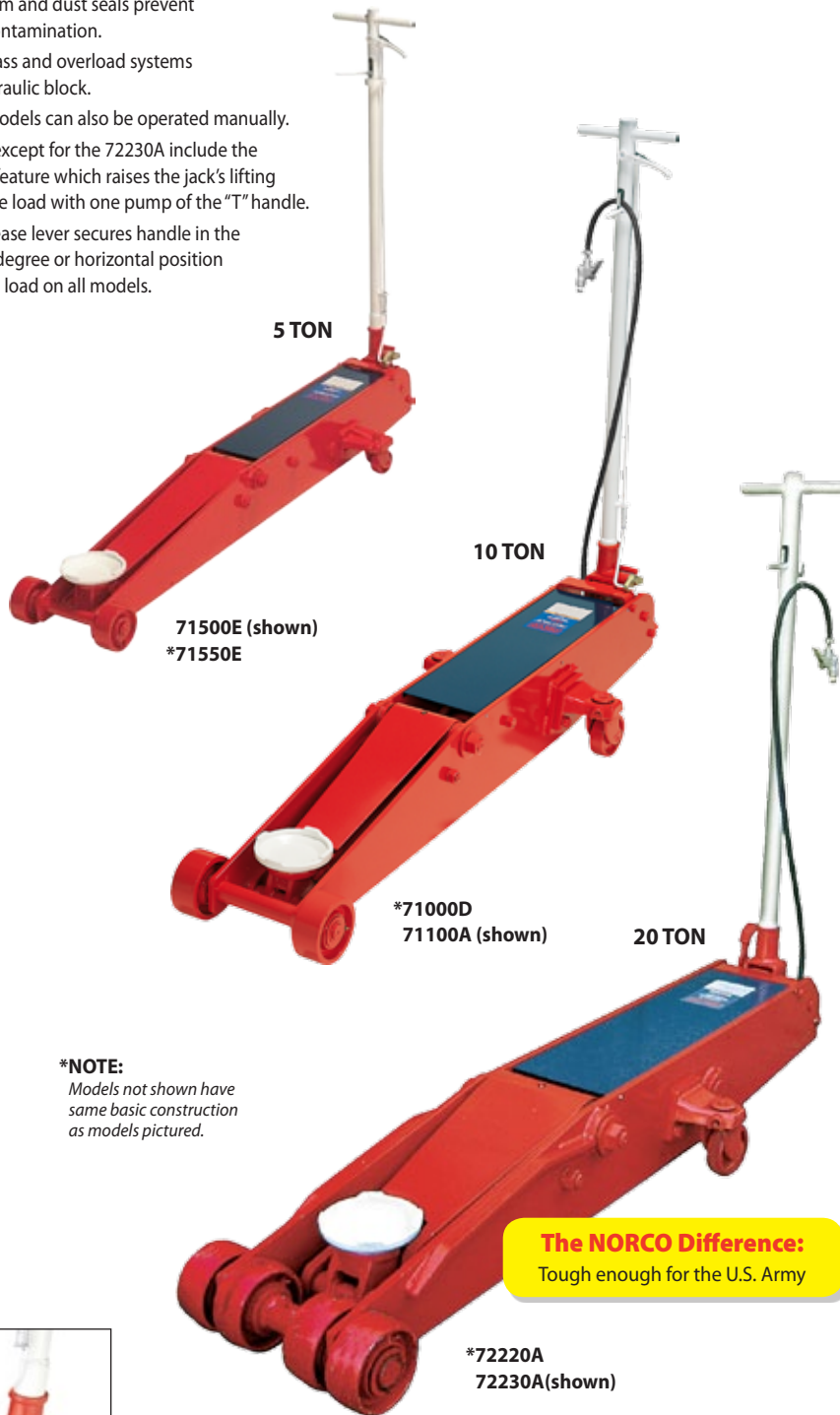

5 TON

71500E (shown)
*71550E

10 TON

*71000D
71100A (shown)

20 TON

*72220A
72230A (shown)

***NOTE:**
Models not shown have same basic construction as models pictured.

The NORCO Difference:

Tough enough for the U.S. Army

FASTJACK® 71500E

5 TON CAPACITY

FASTJACK® 71550E

5 TON CAPACITY (Air & Hydraulic)

INTENDED USE

Truck fleet, truck and farm equipment dealers and bus company garages.

The NORCO Difference:

One pump to reach the load

FASTJACK® 71000D

10 TON CAPACITY

FASTJACK® 71100A

10 TON CAPACITY (Air & Hydraulic)

FASTJACK® 72220A

20 TON CAPACITY

72230A

20 TON CAPACITY (Air & Hydraulic)

INTENDED USE

Heavy duty truck, heavy construction and agricultural equipment maintenance garages.



FASTJACK® mechanism raises the jack's lifting saddle to the load in one pump stroke.
U.S. PATENT NUMBER 7,055,801 B2



| MODEL NUMBER | CAPACITY | LIFT HEIGHT | | OVERALL DIMENSIONS | | HANDLE LENGTH | SHIPPING WEIGHT |
|---------------|----------------------------|-------------|--------|--------------------|--------|---------------|-----------------|
| | | Low | High | Length | Width | | |
| 71500E | 5 Ton | 5.625" | 27.25" | 62.25" | 16.75" | 40" | 270 lbs. |
| 71550E | 5 Ton @ 120 P.S.I. | 5.625" | 27.25" | 62.25" | 16.75" | 40" | 270 lbs. |
| 71000D | 10 Ton | 6.125" | 27.25" | 68.5" | 21" | 46.75" | 455 lbs. |
| 71100A | 10 Ton @ 120 P.S.I. | 6.125" | 27.25" | 68.5" | 21" | 46.75" | 466 lbs. |
| 72220A | 20 Ton | 7.25" | 26.25" | 71.5" | 20.75" | 45" | 650 lbs. |
| 72230A | 20 Ton @ 120 P.S.I. | 7.25" | 26.25" | 71.5" | 20.75" | 45" | 670 lbs. |

71202A FASTJACK®**2 TON CAPACITY FLOOR JACK****INTENDED USE**

A heavy-duty professional quality floor jack designed for a variety of automotive shop uses including the day to day rigors of the tire changing industry.

71228**STEEL WHEEL KIT**

Fits model 71202A

Weight: 10 lbs.

**71226****HANDLE PROTECTOR KIT**

Fits models 71202A, 71233A & 71335
Weight: 1 lbs.



| MODEL NUMBER | CAPACITY | LIFT HEIGHT | | OVERALL DIMENSIONS | | SHIPPING WEIGHT |
|---------------|--------------|-------------|---------|--------------------|--------|-----------------|
| | | Low | High | Length | Width | |
| 71202A | 2 Ton | 3.5" | 20.375" | 28.75" | 15.25" | 102 lbs. |

**71233A****2 TON CAPACITY DOUBLE PUMP FLOOR JACK****INTENDED USE**

An economical floor jack designed for a variety of automotive shop uses where strength, speed, and dependability are required.

The NORCO Difference:

Economical performance

FEATURES

- Extremely low 2-3/4" low lift height.
- Safety by-pass system protects pressure cylinder.
- Safety overload system prevents jack from being used beyond its rated capacity.
- Heavy duty chassis for added strength and dependability.
- 50.25" long two-piece handle for easy shipping and storage.
- Foam handle sleeve is included to protect vehicles from damage.
- Dual pump piston design raises the jack to maximum height in 8-1/2 pump strokes.
- U-joint release mechanism for more control.

| MODEL NUMBER | CAPACITY | LIFT HEIGHT | | OVERALL DIMENSIONS | | SHIPPING WEIGHT |
|---------------|--------------|-------------|------|--------------------|---------|-----------------|
| | | Low | High | Length | Width | |
| 71233A | 2 Ton | 2.75" | 20" | 27.875" | 14.625" | 92 lbs. |



The NORCO Difference:
Lightweight yet durable

NORCO

FLOOR SERVICE JACKS

5

FEATURES

- Thick aluminum side plates.
- 48" long two-piece handle with foam handle sleeve.
- Heavy duty aluminum front and rear wheels.
- Two-speed pump piston raises the saddle to the load quickly.
- Two grab handles provide more convenient lifting of the jack.
- Steel lift saddle for greater durability and strength.
- High lift height may be increased by 3" with optional model 71303 extension adapter.

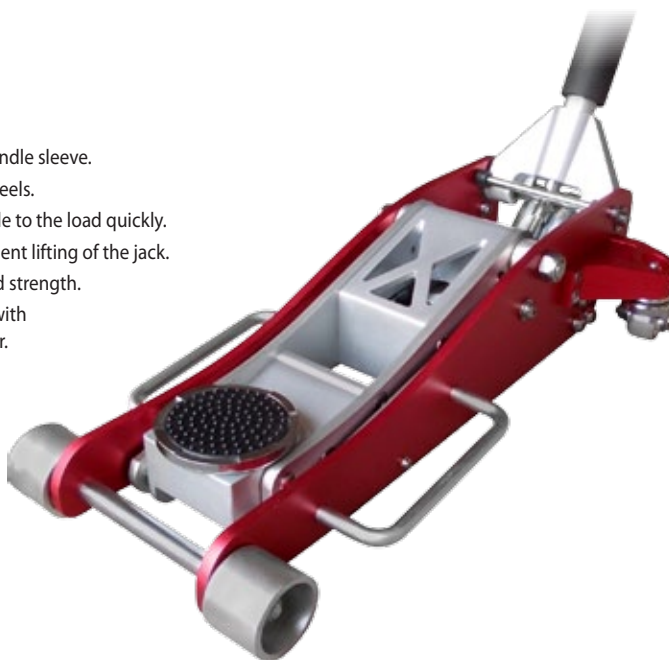

| MODEL NUMBER | CAPACITY | LIFT HEIGHT | | OVERALL DIMENSIONS | | SHIPPING WEIGHT |
|--------------|--------------|-------------|------|--------------------|-------|-----------------|
| | | Low | High | Length | Width | |
| 71330 | 3 Ton | 3.75" | 19" | 26" | 13.5" | 59 lbs. |

71330

**3 TON CAPACITY
LIGHTWEIGHT
FLOOR JACK**

INTENDED USE

A lightweight jack designed for a variety of automotive shop uses. Ideal for roadside service calls.

71303

**3" SADDLE
EXTENSION
ADAPTER**

Fits model 71330 & 71335

Weight: 5 lbs.



U.S. PATENT NUMBER D683104

FEATURES

- Steel hydraulic block construction includes a double pump piston design that quickly raises the jack to the maximum height.
- 50" long, two piece handle with knurled hand grip and foam handle sleeve provides:
 - Ease of pumping.
 - Longer reach for positioning under overhang.
 - Ease for transportation and storage.
 - Ease of pumping in tight quarters when second handle section is removed.
- 4" low and 21-3/8" maximum lift heights (without saddle adapter).
- 7" low and 24-3/8" maximum lift heights (with saddle adapter).
- Safety by-pass system protects pressure cylinder.
- Safety overload system prevents jack from being used beyond its rated capacity.
- Heavy-duty chassis for added strength and dependability.
- Also available is our unique 3" saddle extension adapter (Model 71303). Its patented design has been created to quickly lift the load. Since most SUVs and service trucks have a higher, low lift height, the increased height of the saddle allows for quicker positioning and quicker lifting of the vehicle. It saves time and effort and increases shop efficiency.

The NORCO Difference:
Highest lift height on the market with 71303 extension adapter



| MODEL NUMBER | CAPACITY | LIFT HEIGHT | | OVERALL DIMENSIONS | | SHIPPING WEIGHT |
|--------------|------------------|-------------|---------|--------------------|---------|-----------------|
| | | Low | High | Length | Width | |
| 71335 | 3-1/2 Ton | 4" | 21.375" | 28.5" | 14.375" | 106 lbs. |

71335

**3-1/2 TON CAPACITY
SUV & SERVICE
TRUCK JACK**

INTENDED USE

A heavy-duty floor jack designed for a variety of automotive shop uses including the added capacity and maximum lift height required to handle most SUVs and 1 Ton+ service trucks.

71303

**3" SADDLE
EXTENSION
ADAPTER**

Fits model 71330 & 71335

Weight: 5 lbs.



U.S. PATENT NUMBER D683104

The NORCO Difference:
Spring-loaded locking mechanism
and hidden foot pads

81004C & 81006D

PAIRS OF STANDS 3 & 6 TON CAPACITY

(Each Stand)

INTENDED USE

For automotive use
where vehicle is to be
supported before
making repairs.

81012

PAIR OF STANDS 12 TON CAPACITY

(Each Stand)

INTENDED USE

Fleet garages, agricultural
and construction
maintenance shops.

FEATURES

- Unique spring loaded pawl provides constant locking pressure against lifting column.
- Four legged base with foot pads for added strength and a more secure footing on asphalt.
- Common machine bolt secures lifting column to stand and provides added strength when stand is continuously lifted and handled by the column.
- Recessed column saddle for acceptance of vehicle panel rail (model 81004C only).
- Positive lock handle cannot be disengaged until load is off the saddle column. Lock handle can be used as a carrying handle.

**ALL STANDS ARE
INTENDED TO BE
USED IN PAIRS.**



81004C
(3 TON)

81006D
(6 TON)

81012
(12 TON)

| MODEL NUMBER | CAPACITY (Each Stand) | HEIGHT | | HEIGHT INTERVALS | BASE SIZE | SADDLE SIZE | SHIPPING WEIGHT |
|---------------|-----------------------|---------|---------|------------------|---------------|-----------------|-----------------|
| | | Low | High | | | | |
| 81004C | 3 Ton | 12" | 17.5" | .5625" | 7.5" x 7.875" | 1.125" x 4.625" | 19 lbs. |
| 81006D | 6 Ton | 16.25" | 24.875" | .625" | 10" x 11" | 1.125" x 4.875" | 30 lbs. |
| 81012 | 12 Ton | 19.625" | 29.375" | 1.25" | 13" x 15" | 1.625" x 4.75" | 86 lbs. |



TRUCK RAMPS

NORCO

The NORCO Difference:
Your choice of narrow or wide ramps

82019

82020

PAIR OF TRUCK RAMPS 20 TON CAPACITY

(10 Ton Each Ramp)

INTENDED USE

Elevates front or rear of vehicle for
access to frame and components.
Particularly useful on vehicles with
low profile or ground-effects.

FEATURES

- Handles tires with up to 16" tread widths.
- Telescopic 34" T-handle extends and lifts up to expose wheels for easy maneuverability around the shop. Retracts for easy storage.
- Perforated holes in ramps provide traction for the tires.
- Non-skid rubber base pads prevent slippage when driving onto or off of ramps.

*82019
82020 (shown)



| MODEL NUMBER | CAPACITY (Each Ramp) | OVERALL DIMENSIONS | | | SHIPPING WEIGHT |
|--------------|----------------------|--------------------|---------|--------|-----------------|
| | | Length | Width | Height | |
| 82019 | 10 Ton | 48.25" | 12.625" | 9" | 204 lbs. |
| 82020 | 10 Ton | 50.5" | 18.375" | 9.25" | 346 lbs. |



*NOTE: Model not shown
has same basic construction
as model pictured.

The NORCO Difference:

We offer a choice of American or import models

NORCO

JACK STANDS

7



81205 (shown)
***81205i**
(5 TON)

FEATURES

- Pin type support column adjusts to four different height positions.
- Heavy duty adjustment pin is secured to stand to prevent loss.
- Handle provides ease of positioning and carrying.
- 9" square base secures and stabilizes load.

***NOTE:**

Models not shown have same basic construction as model pictured. Import models differ slightly from models made in U.S.A.

FEATURES

- Pin type support column adjusts to multiple height positions. See specification chart below.
- Adjustment pin is secured to stand to prevent loss.
- Four legged base made of heavy schedule 2" diameter pipe for added stability.
- Large support saddle with locating lugs position and center load.



***81208**
***81208i**
(SHORT HEIGHT)

81209 (shown)
***81209i**
(MED. HEIGHT)

***81210**
***81210i**
(HIGH HEIGHT)
(10 TON)



81225 (shown)
***81225i**
(25 TON)

FEATURES

- Pin type support column adjusts to four different height positions.
- Adjustment pin is secured to stand to prevent loss.
- Handle provides ease of positioning and carrying.
- 3/8" thick solid steel base plate for added stability.



81205

IMPORT 81205i

PAIR OF STANDS
5 TON CAPACITY

(Each Stand)

INTENDED USE

Low profile design in order to support forklifts and heavy machinery.



81208

IMPORT 81208i

PAIR OF STANDS
SHORT HEIGHT
10 TON CAPACITY

(Each Stand)



81209

IMPORT 81209i

PAIR OF STANDS
MEDIUM HEIGHT
10 TON CAPACITY

(Each Stand)



81210

IMPORT 81210i

PAIR OF STANDS
HIGH HEIGHT
10 TON CAPACITY

(Each Stand)

INTENDED USE

Fleet garages, agricultural and construction maintenance shops where a pin type height adjustment column is desired.



81225

IMPORT 81225i

PAIR OF STANDS
25 TON CAPACITY

(Each Stand)

INTENDED USE

Fleet and maintenance garages where low profile stands are used to support trucks and loaded trailers.

ALL STANDS ARE INTENDED TO BE USED IN PAIRS.

| MODEL NUMBER | CAPACITY (Each Stand) | HEIGHT | | HEIGHT INTERVALS | BASE SIZE | SADDLE SIZE | SHIPPING WEIGHT | |
|--------------|-----------------------|---------------|-------|------------------|-----------|---------------|-----------------|----------|
| | | Low | High | | | | | |
| 81205 | 81205i | 5 Ton | 9.5" | 15.75" | 3 x 2" | 9" x 9" | 3" x 4.5" | 38 lbs. |
| 81208 | 81208i | 10 Ton | 10.5" | 17" | 4 x 1.5" | 12.5" x 12.5" | 3" x 5" | 60 lbs. |
| 81209 | 81209i | 10 Ton | 18.5" | 30" | 7 x 1.5" | 17" x 17" | 3" x 5" | 80 lbs. |
| 81210 | 81210i | 10 Ton | 28" | 47" | 10 x 2" | 16" x 16" | 3" x 5" | 106 lbs. |
| 81225 | 81225i | 25 Ton | 12" | 20" | 3 x 3" | 10" x 10" | 2.25" x 3.25" | 65 lbs. |



81022A**IMPORT 81022Ai****20 TON CAPACITY****INTENDED USE**

To stabilize and assist in supporting the front or rear end of a loaded or unloaded tractorless trailer. Sold individually but generally used in pairs.

81033A**3/4 TON CAPACITY****81034A****3/4 TON CAPACITY****INTENDED USE**

Designed to support vehicle components, not the vehicle. Ideal for exhaust system installation, shock absorber replacement and any task which requires relieving pressure off components.

81035A**1-1/2 TON CAPACITY****INTENDED USE**

To assist in stabilizing and supporting a vehicle that is raised by an in-ground or above-ground lift. Should be used in pairs.

81036A**1 TON CAPACITY****INTENDED USE**

For lifting and positioning exhaust systems, shock absorbers and MacPherson struts. Hydraulic power will assist in freeing frozen spring shackles, aligning wheels and steering gear adjustments.

**81022A
81022Ai**
 (20 TON)

**81034A (shown)
81033A (without pedal)**
 (3/4 TON)

81035A
 (1-1/2 TON)

81036A
 (1 TON)
FEATURES**(Models 81022A & 81022Ai)**

- Meets OSHA requirements for supporting trailers when loaded or unloaded.
- 14" diameter base provides maximum leveling stability.
- Quick adjust spin handle for ease of turning.
- Large diamond plate saddle to grip the load.
- 1-1/2" diameter, grade 5, heavy duty screw and nut provide maximum strength and fine adjustment.

FEATURES**(Models 81033A & 81034A)**

- Lightweight, slender design makes handling easy, even in close quarters.
- Quick adjust spin handle with thrust bearing eliminates wear and provides ease of turning under load.
- Foot pedal (Model 81034A only) generates 1" additional stroke and 400 pounds of force at the saddle.
- Pedal may be locked in vertical position for storage or shipment.
- 1-1/4" diameter acme threaded screw has 26-1/4" of travel.

FEATURES**(Model 81035A)**

- An adjustment pin chained to the stand secures the support column at 6 different height positions.
- Quick adjust spin handle with thrust bearing eliminates wear and provides ease of turning under load.
- 1-1/4" diameter acme threaded screw has 6-1/2" of travel for fine adjustment.
- 5/8" thick rubber saddle pad.

FEATURES**(Model 81036A)**

- Foot activated pump and lowering pedals allow use of both hands to position components.
- Spring return lowering pedal automatically closes the release valve when foot is removed from pedal.
- 16" hydraulic travel.
- Telescopic support tube with nine height adjustments at 2-1/2" increments.
- A 12" diameter, 3/8" thick steel base provides added stability.
- Two 3" diameter wheels provide easy maneuvering of stand into work position or around the shop.

| MODEL NUMBER | CAPACITY (Each Stand) | LOW HEIGHT | EXTENDED HEIGHT | BASE SIZE | SADDLE SIZE | SHIPPING WEIGHT |
|------------------------------|-----------------------|------------|-----------------|-----------------|----------------|-----------------|
| 81022A 81022Ai | 20 Ton | 39" | 50.625" | 14" Dia. | 4.5" x 5" | 52 lbs. |
| 81033A | 3/4 Ton | 55.25" | 81.5" | 12" Dia. | 1.625" x 5.25" | 36 lbs. |
| 81034A | 3/4 Ton | 55.25" | 81.5" | 12" Dia. | 1.625" x 5.25" | 40 lbs. |
| 81035A | 1-1/2 Ton | 48.875" | 85.375" | 12" x 12" x 12" | 3.25" x 3.25" | 48 lbs. |
| 81036A | 1 Ton | 56.25" | 94.375" | 12" Dia. | 4" x 6.25" | 51 lbs. |



The NORCO Difference:

No tires? No problem.



CAR DOLLY

9

FEATURES

- Supports a vehicle with or without tires.
- Allows FWD vehicle to be easily moved in the service bay when drive train has been removed.
- Universal design fits any car without the need for additional vehicle adapters.
- Quick and independent width and height adjustments. Fully adjustable outriggers to fit any vehicle frame width. Threaded lift saddles with rubber pads are independently adjustable and provide maximum frame protection.
- Does not require installation to the subframe or engine/transaxle cradle mounting holes.
- Can be used in pairs for maximum maneuverability in tight places.
- Four 6" diameter ball bearing mounted swivel caster wheels rated at 900 pounds capacity each.



78090

3600 LBS. CAPACITY

INTENDED USE

For easy movement of vehicles that have been rendered inoperable due to engine / transaxle removal or other mechanical problems. Frees up lifts and floor jacks for other work to be performed. Used in automobile repair, collision repair, and vehicle inspection applications.



| MODEL NUMBER | CAPACITY | HEIGHT ADJUSTMENT | WIDTH | LENGTH ADJUSTMENT | SHIPPING WEIGHT |
|--------------|-------------------|-------------------|-------|-------------------|-----------------|
| 78090 | 3,600 lbs. | 12.75" to 15.75" | 17" | 30" to 60" | 65 lbs. |

The NORCO Difference:

Smooth and easy operation



MECHANICAL SCISSORS JACK



FEATURES

- Combination right and left hand threaded drive screw for faster rising.
- Includes 2-piece extra long 22.5" crank handle for easier operation under load, longer reach and convenient storage when not in use.

82002C

1-1/2 TON SCISSORS JACK

Passenger car tire changing.



| MODEL NUMBER | CAPACITY | LIFT HEIGHT | | BASE DIMENSIONS | SADDLE SIZE | SHIPPING WEIGHT |
|---------------|------------------|-------------|--------|-----------------|-------------|-----------------|
| | | Low | High | | | |
| 82002C | 1-1/2 Ton | 3.75" | 13.25" | 4.25" x 7.375" | 2" x 5.125" | 10 lbs. |

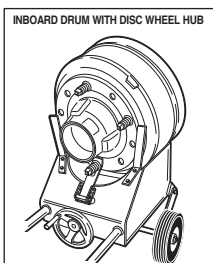
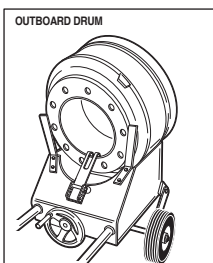

BRAKE DRUM HANDLER

FEATURES

- Reduces lost-time injuries.
- Handles 15" and 16-1/2" drums.
- 35-1/2" handle for easy positioning during installation & removal.
- Machine rotating handle provides ease of raising and lowering drum.
- 8" diameter ball bearing wheels, semi-pneumatic tires and 3/4" diameter axle provide easy maneuverability and balance of drum.
- Adjustable angle bracket secures both outboard and inboard mounted drums with disc wheel hubs to the drum handler's carriage.
- Detachable handle for convenient storage.

72040B

INTENDED USE

Designed for removing, installing and transporting outboard mounted brake drums and inboard mounted drums with disc wheel hubs.

The NORCO Difference:
Handles inboard & outboard drums



| MODEL NUMBER | LIFT HEIGHT | | OVERALL DIMENSIONS | | SHIPPING WEIGHT |
|---------------|-------------|--------|--------------------|-------|-----------------|
| | Low | High | Length | Width | |
| 72040B | 10.25" | 15.25" | 62.5" | 21" | 64 lbs. |

79324F

3 TON CAPACITY AIR / HYDRAULIC PUMP OPERATED

INTENDED USE

For use in conjunction with above ground lifts. The bridge straddles the lift rails and raises the vehicle's tires off the rails for wheel alignment, brake, tire and suspension work.



79326D

FLAT-END ADAPTER BRACKET KIT

enables the Rolling Lift Bridge to roll on flat surfaces.
Weight: 12 lbs. per set of 4.

79327D

HOOK-END ADAPTER BRACKET KIT

enables the Rolling Lift Bridge to roll on the rails of the lift.
Weight: 12 lbs. per set of 4.

FEATURES

- Push button air/hydraulic pump provides safe, quick lifting.
- The lifting pads safely support the vehicle on the bridge and the adjustable lift arms span up to 60°.
- Universal mounting brackets adjust to a lift rail opening of 46-1/2".
- Flat-end and hook-end adapter brackets are equipped with spring-loaded roller bearings for smooth maneuverability of bridge on lift rails. These brackets are sold separately.
- Mechanical stop prevents accidental lowering of bridge.
- Lowering is accomplished with one hand on the release lever and the other hand releasing the mechanical stop.
- Equipped with rubber faced saddle for differential lifting.

| MODEL NUMBER | CAPACITY @ 100 P.S.I. | LIFT HEIGHT | DIMENSIONS | | | SHIPPING WEIGHT |
|---------------|-----------------------|-------------|------------|-------|--------|-----------------|
| | | | Length | Width | Height | |
| 79324F | 3 Ton | Up to 8" | 35" | 19.5" | 9.5" | 290 lbs. |

The NORCO Difference:

Unique combination of adapters allows use on most drive-on four-post lifts or quick-lube pits

79328C

9" EXTENSION ADAPTERS

for use with light duty trucks, vans and 4x4's. The adapter increases the outer saddle height on the sliding lift rail from 1-1/4" to 10-1/2".
Weight: 19 lbs. per pair.

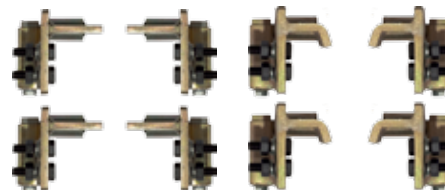

79326D
SOLD IN KITS

79327D
SOLD IN KITS

NOTE:

Adapter bracket kits must be ordered separately to adapt the universal mounting brackets to the above ground lift's rails. The majority of applications will require model 79326D flat-end or model 79327D hook-end adapter kits. Other kits are available upon request.



AIR LIFT JACK

NORCO

The NORCO Difference:

Internal load dampening safety device

IMPORT 82999i

10 TON CAPACITY

INTENDED USE

Truck and farm equipment dealer garages, heavy duty construction repair shops and bus company garages.



FEATURES

- Three-way heavy duty air valve provides fine control when lifting or lowering a vehicle.
- Automatic safety lock engages in six different height positions independent of air pressure.
- Designed for lifting entire front or rear of a vehicle.
- Front swivel caster wheel and two 12-1/4" diameter pneumatic rear tires provide easy maneuverability.
- Adjustable lifting saddles can be raised and extended to desired position.



| MODEL NUMBER | CAPACITY @200 P.S.I. | LIFT HEIGHT | | OVERALL DIMENSIONS | | | SADDLE REACH | SHIPPING WEIGHT |
|---------------|----------------------|-------------|--------|--------------------|--------|--------|--------------|-----------------|
| | | Low | High | Length | Width | Height | | |
| 82999i | 10 Ton | 12.83" | 44.72" | 40.59" | 34.72" | 67.75" | 11.18" | 792 lbs. |

The NORCO Difference:

The longest reach in the industry



LONG REACH AIR LIFT JACK



82995

8-1/2 TON CAPACITY

INTENDED USE

For truck, bus, farm equipment and motor home applications where a long reach jack is required to lift at the vehicle bumper, frame or front axle.

FEATURES

- Three-way heavy duty air valve provides fine control when lifting or lowering a vehicle.
- Automatic safety lock engages in five different height positions independent of air pressure.
- Includes extension tubes and adjustment pins for added height requirements.
- Two 10" diameter solid wheels are strategically located for better positioning and maneuverability.
- Scissors action frame design with four 5" diameter steel wheels provides maximum stability during lifting and lowering.
- Large air cylinder requires only 100 p.s.i. air pressure to lift 5 ton capacity.
- Over four feet of reach between cylinder and center line of lifting saddle.



| MODEL NUMBER | CAPACITY | LIFT HEIGHT | | OVERALL DIMENSIONS | | | SADDLE REACH | SHIPPING WEIGHT |
|--------------|------------------------|-------------|------|--------------------|-------|--------|--------------|-----------------|
| | | Low | High | Length | Width | Height | | |
| 82995 | 5 Ton @ 100 P.S.I. | | | | | | | |
| | 7 Ton @ 150 P.S.I. | 10" | 50" | 80.5" | 38" | 53.75" | 50" | 935 lbs. |
| | 8-1/2 Ton @ 180 P.S.I. | | | | | | | |

The NORCO Difference:

Perfect for lifting trailers



PORTABLE AIR LIFT JACK

82990C

10 TON CAPACITY

INTENDED USE

Garages / repair shops of truck, farm equipment, construction equipment and bus companies. May be used in pairs. Ideal for crowded conditions that require single point contact.

FEATURES

- Three-way heavy duty air valve provides fine control when lifting or lowering a load.
- Extension tubes and detent pins offer multiple lifting heights.
- Unit easily maneuvered on two 8" diameter rubber tread wheels.
- Removable handle and 8' air hose for remote safe positioning and operation.
- Lifting saddle with serrated surface and locating lugs.



| MODEL NUMBER | CAPACITY @172 P.S.I. | LIFT HEIGHT | | OVERALL DIMENSIONS | | | STROKE | SHIPPING WEIGHT |
|--------------|----------------------|-------------|---------|--------------------|---------|--------|--------|-----------------|
| | | Low | High | Length | Width | Height | | |
| 82990C | 10 Ton | 17.75" | 49.375" | 58" | 13.625" | 17.75" | 11.5" | 178 lbs. |

78099**700 LBS. CAPACITY
4 POINT ENGINE
SUPPORT TOOL****INTENDED USE**

The main transverse support bar mounts on the shock strut towers to support engines. Heavier engines can be supported by using one or both front support adapters on the transverse support bar. Weight: 52 Lbs.

**FEATURES**

- Fully adjustable strut tower mounts can be positioned on the transverse support bar up to 47-1/2" apart to fit most vehicles.
- Two front support adapters can mount directly onto the transverse support bar and easily be adjusted to fit any engine compartment configuration.
- Support bar and adapters are made of lightweight steel tubing, welded together in a parallel configuration to prevent flexing and provide full length positioning of the hooks and adapter front mounting feet.
- Three 1/2" diameter hooks 14" long and spin knobs provide strength and quick adjustment to support the engine.

HYDRAULIC TRANSMISSION JACK **NORCO****The NORCO Difference:**

All-new tech friendly design

72050E**1/2 TON CAPACITY****INTENDED USE**

For removal and installation of automobile and light truck transmissions or differentials.

FEATURES

- Wide chassis with open front provides:
 - Wider opening for saddle and transmission to come lower to the ground for easy removal.
 - Efficient load distribution and stability.
 - Easy access to saddle tilt knobs.
- Fully adjustable universal saddle with adjustable corner brackets and safety chain.
- Safety by-pass system prevents damage to cylinder.
- Safety overload system prevents jack from being used beyond its rated capacity.
- Full 360 degree rotating pump handle operates in any position.
- Flash chromed ram inhibits rust from entering the hydraulic system.
- Four full-swivel ball bearing caster wheels for easy positioning.
- Wide chassis for efficient load distribution and stability.



| MODEL NUMBER | CAPACITY | LIFT HEIGHT | | OVERALL DIMENSIONS | | SADDLE SIZE | SHIPPING WEIGHT |
|---------------|----------------|-------------|---------|--------------------|-------|-----------------|-----------------|
| | | Low | High | Length | Width | | |
| 72050E | 1/2 Ton | 7.375" | 32.125" | 36" | 26.5" | 7.125" x 8.125" | 152 lbs. |



NOTE: See optional adapters and saddles on page 18-19.

FEATURES

- Wide chassis with open front provides:
 - Wider opening for saddle and transmission to come lower to the ground for easy removal.
 - Efficient load distribution and stability.
 - Easy access to saddle tilt knobs.
- Fully adjustable universal saddle with adjustable arms to position the transmission.
- Heavy duty chain with convenient chain tensioner secures load to the saddle.
- Safety by-pass system prevents damage to the hydraulic cylinder.
- Safety overload system prevents jack from being used beyond its rated capacity.
- Full 360 degree rotating handle operates in any position.
- Flash chromed ram inhibits rust from entering the hydraulic system.
- Four 4" diameter full-swivel ball bearing caster wheels for easy positioning.



**72000E (shown)
*72000Ei**

***NOTE:**
Model not shown has same basic construction as model pictured. Import model differs slightly from model made in U.S.A.



72000E

IMPORT 72000Ei

1-1/2 TON CAPACITY

INTENDED USE

For heavy truck transmissions. Ideally suited for truck dealers, maintenance and heavy duty transmission repair centers.

OPTIONAL EQUIPMENT



72001

DIFFERENTIAL ADAPTER

is used with models 72000E, 72000Ei, 72700A and 72701A jacks only. Adapter fits most differentials and replaces the universal saddle when used. Weight: 29 lbs.



72003

FULLER® EATON® ROADRANGER® ADAPTER

is used with models 72000E & 72000Ei jacks only. Weight: 21 lbs.



72001



72003

| MODEL NUMBER | CAPACITY | LIFT HEIGHT | | OVERALL DIMENSIONS | | SADDLE SIZE | SHIPPING WEIGHT |
|------------------------------|------------------|-------------|-------|--------------------|-------|-----------------|-----------------|
| | | Low | High | Length | Width | | |
| 72000E 72000Ei | 1-1/2 Ton | 7.75" | 36.5" | 45" | 28" | 10.25" x 15.25" | 310 lbs. |



The NORCO Difference:

Unique saddle handles the largest transmissions

FEATURES

- Fully adjustable saddle with adjustable angle brackets to position the transmission.
- Four 4" high risers handle transmissions with offset transfer cases.
- Two heavy duty ratchet tie-downs conveniently secure the load to the lifting saddle.
- Safety by-pass and overload systems to prevent cylinder damage and prevent the jack from being used beyond its rated capacity.
- Full 360 degree rotating handle operates in any position.
- Flash chromed ram inhibits rust from entering the hydraulic system.
- Four full-swivel ball bearing 4" caster wheels for easy positioning.



72025

1-1/2 TON CAPACITY

INTENDED USE

Same as the model 72000E but with a wider chassis opening plus a broader lift range to handle a larger variety of transmission configurations.



| MODEL NUMBER | CAPACITY | LIFT HEIGHT | | OVERALL DIMENSIONS | | | SADDLE SIZE | SHIPPING WEIGHT |
|--------------|------------------|-------------|-------|--------------------|--------|--------|-----------------|-----------------|
| | | Low | High | Length | Width | Height | | |
| 72025 | 1-1/2 Ton | 4.75" | 36.5" | 43.25" | 32.75" | 12" | 18.25" x 15.25" | 414 lbs. |



72675



1,250 LBS. CAPACITY

INTENDED USE

The Power Train Lift/Table not only handles transmissions and fuel tanks, but also engines and transaxles, rear ends and leaf springs. Also serves as a work table where the components can be lowered to a stable and secure work height for repair.



FEATURES

- An air/hydraulic foot pump includes a metered valve for safe lowering of the load.
- The pump can be removed from its holder, placed closer to the lift saddle, leaving hands free to accurately position the load.
- Fully adjustable saddle with two ratchet tie-downs secure the load to the saddle.
- Four swivel ball bearing caster wheels with polyurethane tread protect floors yet provide easy maneuverability.
- The rear caster wheels have a double locking feature. One lock prevents the rear wheels from turning when the lift is used in a repair mode. The other locks the rear casters in a fixed direction to provide steering ability.
- The optional model 72508 Fuel Tank Saddle Adapter (page 18) can quickly and easily be installed.

72850A



2,500 LBS. CAPACITY

INTENDED USE

This lift table handles power train components like engines and their transmissions, engines with trans-axle assemblies, rear ends and large electric vehicle batteries. It will also serve as a work table where components can be lowered to a convenient work height for repairs.



FEATURES

- An air/hydraulic foot pump includes a metered valve for safe lowering of the load.
- Five foot extension hose with quick disconnect fittings stores in the lift base. The foot pump can be removed from its holder and hydraulic hose quickly and easily extended by 5' using the extension hose. This provides hands free operation of the pump anywhere around the lift's perimeter.
- Scissors lift design provides easy 360° access to any component.
- Two heavy duty ratchet tie-downs are included to safely secure the load on the lift table.
- Table top height from 31" to 80-1/2".
- Four 8" diameter swivel caster wheels for easy maneuverability. Front wheels can be locked in position for steering. Rear wheels can be locked to prevent the lift from rolling.



| MODEL NUMBER | CAPACITY @100 P.S.I. | LIFT HEIGHT | | OVERALL DIMENSIONS | | | TABLE SIZE | SHIPPING WEIGHT |
|---------------|----------------------|-------------|------|--------------------|-------|--------|------------|-----------------|
| | | Low | High | Length | Width | Height | | |
| 72675 | 1,250 lbs. | 30" | 77" | 65" | 43" | 51.25" | 14" x 31" | 480 lbs. |
| 72850A | 2,500 lbs. | 31" | 78" | 50" | 33" | 35" | 19" x 36" | 665 lbs. |

FEATURES

- Fully adjustable universal saddle with adjustable corner brackets and safety chain.
- Safety overload system prevents jack from being used beyond its rated capacity.
- 2" diameter, flash chromed, single stage ram provides added stability throughout the entire lift range.
- Foot operated pump and lowering pedals allow use of both hands to position and align saddle with transmission.
- Wide base with four 3-7/8" diameter heavy duty swivel ball bearing caster wheels provides stability and easy maneuvering.

NOTE: See optional adapters and saddles on pages 13 & 18.



| MODEL NUMBER | CAPACITY | LIFT HEIGHT | | BASE DIMENSIONS | SHIPPING WEIGHT |
|---------------|--------------|-------------|--------|-----------------|-----------------|
| | | Low | High | | |
| 72700A | 1 Ton | 45.75" | 74.25" | 38" x 38" | 292 lbs. |

72700A

1 TON CAPACITY

INTENDED USE

Designed for the removal, installation and transportation (in the lowered position) of heavy duty truck transmissions that are raised by an in-ground or above-ground lift.



The NORCO Difference:

Maneuverability and stability for safe transmission service

FEATURES

- Air/hydraulic foot pump provides hands free operation and easy convenient lifting.
- Metered pump valve provides safe lowering of load.
- Fully adjustable universal saddle with adjustable arms to position the transmission.
- Heavy duty chain with convenient chain tensioner secures load to saddle.
- 2" diameter, flash chromed, single stage ram provides added stability throughout the entire lift range.
- Wide base with four 3-7/8" diameter heavy duty swivel ball bearing caster wheels provides stability and easy maneuvering.

NOTE: See optional adapters and saddles on pages 13 & 18.



72701A

1 TON CAPACITY AIR/HYDRAULIC

INTENDED USE

Same as the model 72700A but with the added convenience of an air/hydraulic foot pump.



| MODEL NUMBER | CAPACITY @100 P.S.I. | LIFT HEIGHT | | BASE DIMENSIONS | SHIPPING WEIGHT |
|---------------|----------------------|-------------|---------|-----------------|-----------------|
| | | Low | High | | |
| 72701A | 1 Ton | 41.25" | 69.375" | 37.5" x 38" | 273 lbs. |

72500E

TELESCOPIC 1/2 TON CAPACITY SINGLE PUMP

INTENDED USE

Designed for the removal, installation and transportation (in the lowered position) of transmissions and transfer cases on passenger cars, vans and light trucks that are raised by an in-ground or above-ground lift.

FEATURES

- Fully adjustable universal saddle with hand adjustable corner brackets and safety chain.
- Safety overload system prevents jack from being used beyond its rated capacity.
- Foot operated pump and lowering pedals allow use of both hands to position and align saddle with transmission.
- Two-stage flash chromed rams inhibit rust from entering hydraulic system.
- Wide base with four easy rolling 4" diameter swivel ball bearing caster wheels, provides stability and easy maneuvering in its lowered position.
- Polyurethane wheels provide protection for expensive tile and epoxy floors.

| MODEL NUMBER | CAPACITY | LIFT HEIGHT | | BASE DIMENSIONS | SHIPPING WEIGHT |
|---------------|----------|-------------|------|-----------------|-----------------|
| | | Low | High | | |
| 72500E | 1/2 Ton | 35" | 72" | 34" x 37" | 176 lbs. |

**The NORCO Difference:**

The economy of manual operation with the speed of air models

NOTE: See optional adapters and saddles on pages 18-19.

72550B FASTJACK®

TELESCOPIC 1/2 TON CAPACITY DOUBLE PUMP

INTENDED USE

Designed for the removal, installation and transportation (in the lowered position) of transmissions and transfer cases on passenger cars, vans and light trucks that are raised by an in-ground or above-ground lift.

FEATURES

- Fully adjustable universal saddle with hand adjustable corner brackets and safety chain.
- Safety overload system prevents jack from being used beyond its rated capacity.
- Foot operated pump and lowering pedals allow use of both hands to position and align saddle with transmission.
- Two-stage flash chromed rams inhibit rust from entering hydraulic system.
- Wide base with four easy rolling 4" diameter swivel ball bearing caster wheels, provides stability and easy maneuvering in its lowered position.
- Two times faster rising action as model 72500E with no load or a load up to 400 pounds.
- Same rising action as model 72500E for loads between 400 and 1,000 pounds.
- Polyurethane wheels provide protection for expensive tile and epoxy floors.

U.S. PATENT NO. 5,975,496

(Double Pump Design)

| MODEL NUMBER | CAPACITY | LIFT HEIGHT | | BASE DIMENSIONS | SHIPPING WEIGHT |
|---------------|----------|-------------|------|-----------------|-----------------|
| | | Low | High | | |
| 72550B | 1/2 Ton | 35" | 72" | 34" x 37" | 178 lbs. |





FEATURES

- Air/hydraulic foot pump provides hands free operation and easy, convenient lifting.
- Metered pump valve provides safe lowering of load.
- Fully adjustable universal saddle with hand adjustable corner brackets and safety chain.
- Safety overload system prevents jack from being used beyond its rated capacity.
- Two-stage flash chromed rams inhibit rust from entering hydraulic system.
- Wide base with four easy rolling 4" diameter polyurethane, swivel ball bearing caster wheels (one is a locking caster wheel) provides stability and easy maneuvering in its lowered position.
- Polyurethane wheels provide protection for expensive tile and epoxy floors.

FASTJACK® 72450B

**TELESCOPIC
1/2 TON CAPACITY
AIR/HYDRAULIC**

INTENDED USE

Designed for the removal, installation and transportation (in the lowered position) of transmissions and transfer cases on passenger cars, vans and light trucks that are raised by an in-ground or above-ground lift.

U.S. PATENT NO. 7,171,807



| MODEL NUMBER | CAPACITY | LIFT HEIGHT | | BASE DIMENSIONS | SHIPPING WEIGHT |
|---------------|----------------|-------------|------|-----------------|-----------------|
| | | Low | High | | |
| 72450B | 1/2 Ton | 36" | 75" | 34" x 34" | 175 lbs. |

NOTE: See optional adapters and saddles on pages 18-19.

The NORCO Difference:

Simultaneous operation of two-stage ram for speedy transmission repair



FEATURES

- Air/hydraulic foot pump provides hands free operation and easy, convenient lifting.
- Metered pump valve provides safe lowering of load.
- Fully adjustable universal saddle with hand adjustable corner brackets and safety chain.
- Safety overload system prevents jack from being used beyond its rated capacity.
- Two-stage flash chromed rams inhibit rust from entering hydraulic system.
- Wide base with four easy rolling 4" diameter polyurethane, swivel ball bearing caster wheels (two are locking caster wheels) provides stability and easy maneuvering in its lowered position.
- Comes with a larger 10-1/4" x 15-1/8" saddle plate and four adjustable "L"-shaped locating bars.
- Polyurethane wheels provide protection for expensive tile and epoxy floors.

FASTJACK® 72475A

**TELESCOPIC
3/4 TON CAPACITY
AIR / HYDRAULIC**

INTENDED USE

Designed for the removal, installation and transportation (in the lowered position) of transmissions and transfer cases on passenger cars and up to one ton capacity vans and trucks that are raised by an in-ground or above-ground lift.

U.S. PATENT NO. 7,171,807



| MODEL NUMBER | CAPACITY | LIFT HEIGHT | | BASE DIMENSIONS | SHIPPING WEIGHT |
|---------------|----------------|-------------|--------|-----------------|-----------------|
| | | Low | High | | |
| 72475A | 3/4 Ton | 36.5" | 75.25" | 36" x 36" | 196 lbs. |

For use with all NORCO floor and under hoist transmission jacks.

72531



AUTOMOTIVE TO HEAVY DUTY SADDLE ADAPTER

INTENDED USE

Allows any automotive adapter to be attached to any heavy duty under hoist transmission jack.
Weight: 18 lbs.



72531

This unique adapter allows any NORCO automotive transmission saddle adapter to be used with the NORCO heavy duty transmission jacks: 72700A or 72701A. This economical design can save a shop thousands of dollars by allowing one transmission jack to be used for both heavy duty truck and automotive applications.

72514



MERCEDES 722 ADAPTER

INTENDED USE

For use on Mercedes #722 transmissions.
Weight: 12 lbs.



72514

An optional saddle adapter which is used in conjunction with a NORCO under hoist transmission jack to remove, install and transport (in the lowered position) later model Mercedes 722 transmissions.

72508



FUEL TANK SADDLE

INTENDED USE

An optional saddle adapter which is used in conjunction with a NORCO transmission jack to remove, install and transport (in the lowered position) automobile and light truck emptied fuel tanks and other undercar components.
Weight: 37 lbs.

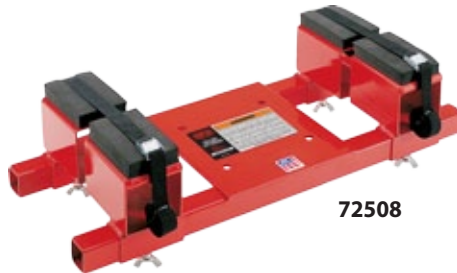

72508

FEATURES

- Handles automotive and light duty truck fuel tanks up to 40 gallon capacity. Tanks are to be emptied before handling.
- Four adjustable support risers with rubber pads protect the fuel tank and can be quickly positioned to fit many shapes and sizes.
- Includes two load restraint straps.

72525

QUICK-ADJUST SADDLE

INTENDED USE

An optional saddle that replaces the 4 adjustable corner brackets found on the standard universal saddle.
Weight: 19 lbs.



72525

FEATURES

- Quickly adapts to the existing universal saddle plate.
- Four low profile ratcheting arms quickly and easily adjust to the transmission pan configuration.

72529



Diesel Exhaust Adapter for F-250, 350, 450, 550 Super Duty with a 6.7L Diesel.
Weight: 42 lbs.



72529

72034

CLUTCH SADDLE 300 LBS. CAPACITY

INTENDED USE

An optional saddle adapter which is used in conjunction with all NORCO under hoist transmission jacks (pages 16-17).
Weight: 22 lbs.



72034

The NORCO Difference:

Unique vehicle & service specific adapters save time and enhance safety



For use with all NORCO floor and under hoist transmission jacks.



72509



72509

For use on Ford 5R55W, 4R70W, AX4N, AXOD METRIC transmissions. This one adapter can quickly and easily be adjusted to fit four different transmission configurations. Weight: 38 lbs.



72004



72004

For use on Ford 6R140 Transmissions Weight: 32 lbs.

CD4E VEHICLE APPLICATIONS:

- 1994–2002 Mazda 626 4-cylinder
- 1994–1997 Mazda MX-6 4-cylinder
- 1994–1997 Ford Probe 4-cylinder
- 1995–2000 Ford Contour
- 1995–2000 Mercury Mystique
- 1995–2007 Ford Mondeo
- (up to Mondeo III 4 cylinder model)
- 1999–2002 Mercury Cougar
- 2001–2007 Ford Escape
- 2001–2006 Mazda Tribute
- 2005–2007 Mercury Mariner



72513



72513

For use on Ford CD4E transmissions. Weight: 17 lbs.

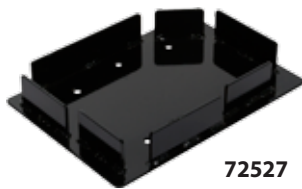

72527

4F27E VEHICLE APPLICATIONS:

- Ford EcoSport with 2.0L Duratec engine
- Ford Focus with 2.0L Zetec engine & 2.3L Duratec engine
- Ford Fiesta 2008+, with 1.4L, 96hp engine
- Mazda Protegé
- Mazda3
- Mazda6



72527

For use on Ford 4F27E transmissions. Weight: 15 lbs.

6R80 VEHICLE APPLICATIONS:

- 2008–2010 Ford Expedition
- 2008–2010 Lincoln Navigator
- 2008–2010 Ford Explorer
- 2007–2010 Ford Explorer Sport Trac
- 2008–2010 Mercury Mountaineer
- 2009–2012 Ford F-150
- 2011 Ford Territory (SZ-series TCDi model)
- 2011–2012 Ford Mustang V6, GT



72528



72528

For use on Ford 6R80 transmissions. Weight: 24 lbs.



72512

For use on Ford and Lincoln 6F50 and GM 4T60E transmissions. Weight: 25 lbs.

72507B



For use on Ford E40D, 5R110 and 4R100 truck transmissions. F250 - F550 Super Duty. Weight: 35 lbs.



72507B



72512



72035

300 LBS. CAPACITY TELESCOPIC UNDER HOIST AIR / HYDRAULIC

INTENDED USE

Designed for the removal, installation and transportation (in the lowered position) of 14" and 15-1/2" heavy duty clutches and flywheels on trucks that are raised by an in-ground or above-ground lift.

FEATURES

- Tilting saddle activated by an integrated screw with machine handle enables the clutch to be positioned in either a horizontal position for clearing underneath truck or vertical position for installation and removal.
- 2" and 1-3/4" diameter spline shafts rotate 360° for clutch and engine alignment.
- Air/hydraulic foot pump provides hands free operation and easy, convenient lifting.
- Metered pump provides safe lowering of load.
- Two-stage flash chromed rams inhibit rust from entering hydraulic system.
- Polyurethane wheels provide protection for tile and epoxy floors.

U.S. PATENT NO. 7,171,807

| MODEL NUMBER | CAPACITY | LIFT HEIGHT | | BASE DIMENSIONS | SHIPPING WEIGHT |
|--------------|----------|-------------|-------|-----------------|-----------------|
| | | Low | High | | |
| 72035 | 300 lbs. | 38.25" | 73.5" | 35" x 35" | 159 lbs. |



The NORCO Difference:

Allows for easy clutch repair with or without a lift



72030B

300 LBS. CAPACITY FLOOR MODEL TYPE HYDRAULIC

INTENDED USE

To remove, install and transport (in the lowered position) both 14" and 15-1/2" heavy duty clutches and flywheels.

FEATURES

- Clutch/flywheel removal and installation becomes a one man job.
- Tilting saddle enables clutch to be positioned in either horizontal position for clearing underneath truck or vertical position for installation and removal.
- Adjustment bolt on saddle aligns clutch and flywheel.
- Spline shaft rotates 360 degrees, turns left and right for clutch and engine alignment. 2" and 1-3/4" spline shafts included.
- Conveniently located release valve and 360 degree rotating pump handle allow jack to be operated in any work position.

OPTIONAL EQUIPMENT for models 72030B and 72035

72033

FLYWHEEL ADAPTER

Weight: 7 lbs.



| MODEL NUMBER | CAPACITY | LIFT HEIGHT | | OVERALL DIMENSIONS | | SHIPPING WEIGHT |
|--------------|----------|-------------|--------|--------------------|-------|-----------------|
| | | Low | High | Length | Width | |
| 72030B | 300 lbs. | 11.5" | 37.75" | 35" | 26.5" | 148 lbs. |



The NORCO Difference:
The most innovative saddle!

norco FORKLIFT JACK

21



FEATURES

- Two lift points (saddle & post) for numerous lifting applications.
- Two-position saddle at scissors end can be quickly rotated to handle either edges or flat surfaces of a load.
- 2-1/2" low lift height at scissors end.
- 30" removable handle for ease of pumping and storage when not in use.
- Metered release mechanism provides slow, controlled lowering of the load.
- Safety overload valve prevents jack from being used beyond its rated capacity.

72036C

5 TON CAPACITY @ SCISSORS END AND POST

INTENDED USE

A versatile jack having a low enough profile to raise forklifts and a high enough profile to raise farm equipment, tractors and some earthmoving equipment.

TWO-POSITION SADDLE @ SCISSORS END



Lifts at edge



Lifts flat surfaces



| MODEL NUMBER | CAPACITY | LIFT HEIGHT | | | | OVERALL DIMENSIONS | | SHIPPING WEIGHT |
|---------------|--------------|-------------|-----------|--------------|---------------|--------------------|--------|-----------------|
| | | POST Low | POST High | SCISSORS Low | SCISSORS High | Length | Width | |
| 72036C | 5 Ton | 17.375" | 31" | 2.5" | 18.25" | 30.25" | 8.375" | 104 lbs. |

The NORCO Difference:
The most economical tire lever

norco TIRE DOLLIES

82310

NARROW SINGLE TIRE HANDLER DOLLY

82312

WIDE SINGLE TIRE HANDLER DOLLY

INTENDED USE

To provide added leverage to easily remove or install truck tire-and-wheel assemblies.



FEATURES

- Heavy-duty tubular steel construction capable of handling 300 pounds.
- Easy grip handle along with improved "bent arm" design improves leverage for easier installation and minimizes back strain.
- Steel alignment rollers allow simple alignment of the wheel to the wheel studs.
- Spring-loaded kickstand offers convenient storage.
- Two models capable of handling tire diameters from 24 to 48 inches.



| MODEL NUMBER | HANDLES TIRES | OVERALL DIMENSIONS | | SHIPPING WEIGHT |
|--------------|------------------|--------------------|--------|-----------------|
| | | Length | Width | |
| 82310 | 24" - 36" | 42.5" | 24.75" | 19 lbs. |
| 82312 | 36" - 48" | 41" | 32" | 22 lbs. |

82302B



1/2 TON CAPACITY

INTENDED USE

For the removal and installation of single, tandem and duplex tires and wheels which are mounted on trucks that are supported above ground level.

The NORCO Difference:

Side-shift feature makes for easy wheel alignment

FEATURES

- Heavy duty lift arms made with ball bearing conveyer rollers which allow easy rotation of wheels for alignment with bolt pattern.
- 7-1/2" of side to side lift arm adjustment eliminates the trial and error method of aligning the rim's lug holes with the wheel drum.
- A 1,500 pound capacity heavy duty winch with 5 to 1 gear ratio provides ease of operation.
- The winch gear design acts as a brake and allows the load to be lowered incrementally if desired and without the need for constant hand pressure against the crank handle.
- A hydraulic jack tilts the lift arms to match the angle of the spindle.
- Safety chain provided to secure tires and wheels to the dolly.
- Maneuverability is made easy by means of two rear mounted ball bearing caster wheels. The caster wheels include a locking mechanism which can prevent the dolly from moving.



82304



1/2 TON CAPACITY AIR/HYDRAULIC

INTENDED USE

This uniquely crafted wheel lift is designed for the removal and installation of single, tandem, and duplex tires and wheels which are mounted on trucks that are supported above ground level.



FEATURES

- The unique, open-chassis design allows for much easier alignment than with the center post designs of our competition.
- Air-operated pump allows the unit to lift the load effortlessly.
- Heavy duty lift arms made with ball bearing conveyer rollers which allow easy rotation of wheels for alignment with bolt pattern.
- 39-1/2" lift range.
- 7" of side to side lift arm adjustment allows for the easy alignment of the rim's lug holes with the wheel.
- 1,000 pound capacity.
- A hydraulic jack provides tilt to the lift arms for easy alignment.
- Safety chain provided to secure tires and wheels to the dolly.
- Maneuverability is made easy by means of two rear mounted ball bearing swivel casters. The caster wheels include a locking mechanism which can prevent the dolly from moving.

| MODEL NUMBER | CAPACITY | LIFT HEIGHT | | WIDTH | LIFT ARMS | | | SIDE to SIDE ADJ. | | OVERALL DIMENSIONS | | | SHIPPING WEIGHT |
|--------------|----------|-------------|--------|---------|-----------|-------------|-------|-------------------|---------|--------------------|---------|----------|-----------------|
| | | LOW | HIGH | | LENGTH | TILT ANGLE | LEFT | RIGHT | L | W | H | | |
| 82302B | 1/2 Ton | 3" | 41.25" | 24.25" | 21" | -2° to +30° | 3.25" | 4.25" | 45.75" | 43.75" | 62" | 315 lbs. | |
| 82304 | 1/2 Ton | 2.125" | 39.5" | 30.875" | 22.125" | -2° to +30° | 2.5" | 4.5" | 49.625" | 44.625" | 69.875" | 476 lbs. | |



TIRE LIFTER



The NORCO Difference:

A real back saver!

82305



300 LB. CAPACITY SINGLE TIRE LIFTER

INTENDED USE

To safely assist a technician with the removal and installation of single wheels on vehicles that are supported on a lift.



FEATURES

- Maneuverability is made easy by means of four swivel caster wheels. Two rear caster wheels include a locking mechanism which can prevent the dolly from moving.
- Unique offset design offers open access from the rear to mount wheel to the vehicle.
- Onboard rollers make for easy stud-to-hole alignment.
- Air-operated pump allows the unit to lift the load effortlessly.
- 6-1/4" low height of support legs.



| MODEL NUMBER | CAPACITY | LIFT TRAVEL | LIFT ARMS | | | | OVERALL DIMENSIONS | | | SHIPPING WEIGHT |
|--------------|----------|-------------|-----------|----------|---------------------|--------|--------------------|--------|-----|-----------------|
| | | | LOW HT. | HIGH HT. | WIDTH | LENGTH | L | W | H | |
| 82305 | 300 lbs. | 51" | 2" | 53" | 20" I.D. / 24" O.D. | 17.5" | 39" | 31.75" | 79" | 215 lbs. |

FEATURES

- Rear swivel caster wheel and rigid front wheels provide positive steering for the model 82300D. Swivel caster wheels both fore and aft provide side to side maneuverability for the model 82301D.
- 4" wheels with polyurethane tread protect floor.
- Lift arms can be adjusted in closer to handle the more common dual wheel combinations and then adjusted outward to handle the larger combinations.
- Lift arms with ball bearing rollers easily rotate vehicle rim for bolt pattern alignment.
- Lift arms supported at both ends minimize wheel movement.
- Adjustable height push bar provides unobstructed access to hub area.
- 3-1/4" travel adjustment on rear caster wheel matches lifting arms with spindle angle.



82300D (shown)
(with rear swivel caster)

82301D
(swivel casters front & rear)
(1 TON)



82300D

1 TON CAPACITY



82301D

1 TON CAPACITY

INTENDED USE

For the removal and installation of single, tandem and duplex tires and wheels.



| MODEL NUMBER | CAPACITY | LIFT TRAVEL | OVERALL DIMENSIONS | | | SHIPPING WEIGHT |
|---------------|--------------|-------------|--------------------|-------|--------|-----------------|
| | | | Length | Width | Height | |
| 82300D | 1 Ton | 7.5" | 50.5" | 44.5" | 39" | 207 lbs. |
| 82301D | 1 Ton | 7.5" | 50.5" | 44.5" | 39" | 209 lbs. |

FEATURES

- Dolly handles any tire diameter and up to 1,500 lbs. combined tire and wheel weight.
- Three 4" diameter swivel ball bearing caster wheels provide easy maneuverability & positioning.
- Travel adjustment on rear locking caster wheel matches lifting arms with spindle angle.
- 6' chain included to secure wheel assembly to dolly during removal & transport.
- Quick disconnect push/pull handle provides unobstructed access to hub area.



82320

3/4 TON CAPACITY

INTENDED USE

For the removal and installation of single, tandem and duplex tires and wheels.



| MODEL NUMBER | CAPACITY | LIFT TRAVEL | LIFT ARMS | | OVERALL DIMENSIONS | | | SHIPPING WEIGHT |
|--------------|----------------|-------------|-----------|--------|--------------------|-------|-----|-----------------|
| | | | SPREAD | LENGTH | L | W | H | |
| 82320 | 3/4 Ton | 4.75" | 26" | 24.5" | 43.5" | 39.5" | 35" | 175 lbs. |

78106A

**FOLDABLE
ENGINE CRANE
2,500 LBS. CAPACITY****INTENDED USE**

Designed to raise, lower and transport automobile engines, transmissions, differentials and other heavy loads with minimal effort.

FEATURES

- Four position telescopic boom with 3/8" proof chain and swivel mounted hook.
- 3 ton capacity hydraulic power unit provides faster raising action and a large diameter ram to withstand angle loads.
- Low profile design (4-3/4" from top of legs to ground) allows positioning under low ground clearance vehicles.
- Quick foldable legs and boom save shop space (22-1/2" x 51-3/4") and prepare crane for transport or storage within seconds.
- 4" diameter front wheels and locking rear caster wheels provide positive steering and easy maneuvering. Locking caster wheels secure crane from moving when in use.

**Folded
Position**

78204A

**1/2 TON CAPACITY
TRUCK CRANE****INTENDED USE**

Same as the model 78106A but mounts in the bed of a truck or on a loading dock.

**FEATURES**

- Four position telescopic boom that folds down for traveling position or storage.
- 5 to 1 gear ratio winch with 20 foot long 1/4" diameter steel cable and hook pulls the load toward the boom.
- Winch gear design acts as a brake and allows the load to be lowered incrementally if desired and without the need for constant hand pressure against the crank handle.
- Hydraulically activated boom lifts the load to the desired height.
- Crane swivels 360 degrees but can be locked in position.

The NORCO Difference:
Designed and built in America

78600B

**3 TON CAPACITY
AIR/HYDRAULIC
FLOOR CRANE****FEATURES**

- Multiple boom positions and leg extensions ranging from 49" to 81" provide maximum stability.
- Boom swivels 10 degrees right or left if base cannot be centered under the load.
- Floor lock secures crane from moving when in use.
- Model 78600B includes a foot activated air/hydraulic foot pump requiring 100 P.S.I. air pressure.
- Model 78605A includes an electro/hydraulic pump requiring 115 VAC.

***78600B
78605A (shown)
(3 TON)**

78605A

**3 TON CAPACITY
ELECTRO/HYDRAULIC
FLOOR CRANE****INTENDED USE**

For lifting heavy items including removal and installation of diesel engines and often their transmissions.

NOTE:

See information concerning air and electro/hydraulic pumps on page 37.

*Model not shown has same basic construction as model pictured.

| MODEL NUMBER | BOOM CAPACITY @ LENGTH | BOOM HEIGHT | | OVERALL DIMENSIONS | | | SHIPPING WEIGHT |
|---------------|-------------------------|-------------|--------|--------------------|--------|--------|-----------------|
| | | Min. | Max. | Height | Width | Length | |
| 78106A | 2,500 lbs. @ 43" | 0" | 88" | 70.75" | 51.75" | 74.5" | 320 lbs. |
| 78204A | 1/2 Ton @ 46.25" | 0" | 68.5" | 64" | 14" | 46.25" | 180 lbs. |
| 78600B | 3 Ton @ 65" | 13" | 149.5" | 90.5" | 51" | 75" | 1,150 lbs. |
| 78605A | 2 Ton @ 97" | 13" | 149.5" | 90.5" | 51" | 75" | 1,182 lbs. |



The NORCO Difference:

Increased technician safety
by leveling the load



ENGINE LOAD LEVELERS

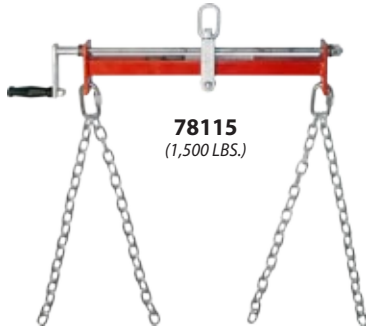

78115
(1,500 LBS.)



78606
(6,000 LBS.)

78115
1,500 LB. CAPACITY
ENGINE LOAD LEVELER

INTENDED USE

Designed to attach to a crane to position automobile and light truck engines and other vehicle components.

FEATURES

- Designed to hook to a crane or hoist to handle and position large, bulky components.
- The horizontal tilt can be adjusted to compensate for off-center loads, or adjusted to a certain angle for a component being positioned.
- Large adjustment handle allows for quick and easy leveling of the load.
- Can be used with NORCO Model 78106A Engine Crane.

FEATURES

- Designed to hook to a crane or hoist to handle and position large, bulky components.
- The horizontal tilt can be adjusted to compensate for off-center loads, or adjusted to a certain angle for a component being positioned.
- Adjustment screw can be used manually or with air tools.
- Can be used with NORCO Model 78600B or 78605A Engine Cranes.
- 5/16" Alloy Grade 80 chain.
- Position of hooks adjusts from 32" to 48".



78606

6,000 LB. CAPACITY
ENGINE LOAD LEVELER

INTENDED USE

Designed to attach to a crane to position heavy duty truck engines and other vehicle components.



| MODEL NUMBER | CAPACITY | OVERALL DIMENSIONS | | | CHAIN LENGTH | SHIPPING WEIGHT |
|--------------|-------------------|--------------------|--------|---------|--------------|-----------------|
| | | Length | Width | Height | | |
| 78115 | 1,500 lbs. | 28.25" | 2.375" | 8.125" | 27" | 20 lbs. |
| 78606 | 6,000 lbs. | 32.187" | 5" | 15.625" | 26.875" | 69 lbs. |

OPTIONAL EQUIPMENT

78109



TRANSMISSION ADAPTER

replaces engine mounting fingers and converts engine stand into a transmission service stand.
Weight: 11Lbs.



FEATURES (78100 / 78100i)

- Fully adjustable engine mounting head.
- Long handle and 360 degree rotating head easily position engine.
- One bolt disassembles stand for transporting or storage.
- Heavy wall tubing prevents excessive frame flex.
- 2 rigid wheels in back and 2 swivel caster wheels in front provide maximum stability and support.



ENGINE STANDS

The NORCO Difference:
A choice of USA made or import stands



78100

IMPORT 78100i

1,000 LBS. CAPACITY
ENGINE STAND

INTENDED USE

For safe handling and positioning of most automotive engines.



78108

IMPORT 78108i

1,250 LBS. CAPACITY
ENGINE STAND

INTENDED USE

Same as models 78100 and 78100i but with heavier construction to handle the largest V8s.



78108
78108i
(1,250 LBS.)

78100
78100i
(1,000 LBS.)



| MODEL NUMBER | CAPACITY | OVERALL DIMENSIONS | | | FINGER ADJUSTMENT | | SHIPPING WEIGHT | |
|--------------|---------------|--------------------|-------|--------|-------------------|-----------|-----------------|----------|
| | | Length | Width | Height | Height | Width | | |
| 78100 | 78100i | 1,000 lbs. | 37" | 34.5" | 38" | 12"-15.5" | 15"-18" | 87 lbs. |
| 78108 | 78108i | 1,250 lbs. | 39" | 36.5" | 39" | 12"-15.5" | 15"-18" | 115 lbs. |

The NORCO Difference:

Gear-driven 360 degree rotation
makes for easier repairs

78200A**2,000 LBS. CAPACITY
ENGINE STAND****INTENDED USE**

A twin-post design capable of handling large automotive engines and small diesel engines ranging between 1,250 and 2,000 pounds.

**FEATURES**

- Includes two universal mounting plates, rotating shaft, eight fully adjustable arms and all the related mounting hardware.
- Rotating shaft with mounting plate telescopes inside the post receiver for fine adjustment when mounting ends or sides of engines. Mounting plates can be adjusted 36-1/4" apart.



Shown with optional
78201 engine adapters.



**OPTIONAL ENGINE
MOUNTING ADAPTERS
(FOR MODEL 78200A)**

MODEL 78201

Ford 6.0L and 6.4L Engine
Adapter for 78200A
Weight: 31 lbs.

**MODEL 78202**

Ford 6.2L Engine
Adapter for 78200A
Weight: 37 lbs.

**MODEL 78203**

Ford 6.7L Engine
Adapter for 78200A
Weight: 37 lbs.

**78125A****1,250 LBS. CAPACITY
ENGINE STAND****INTENDED USE**

For safe handling and positioning of automotive engines weighing up to 1,250 pounds.

FEATURES

- 50:1 ratio gearbox activated by hand crank easily turns the 360 degree rotating head to the desired work position.
- Fully adjustable engine mounting head.
- Two rigid wheels in back and two swivel caster wheels in front provide maximum stability and support. One locking caster wheel secures the stand in the desired work location.
- Telescopic base locks into any one of four different positions to extend the length of the stand for added stability when required.



| MODEL NUMBER | CAPACITY | HEIGHT | WIDTH | | LENGTH | | SHIPPING WEIGHT |
|---------------|------------|--------|--------|------|--------|--------|-----------------|
| | | | Front | Rear | From | To | |
| 78125A | 1,250 lbs. | 42" | 21.25" | 40" | 38.25" | 53.25" | 179 lbs. |
| 78200A | 2,000 lbs. | 42" | 21.25" | 40" | 38.25" | 53.25" | 289 lbs. |



The NORCO Difference:

Gear-driven 360 degree rotation makes for easier repairs



78160

3 TON CAPACITY DIESEL ENGINE STAND

INTENDED USE

For safe handling and positioning of most diesel engines.

FEATURES

- Mounting head tilts for engine clearance in 360 degree rotation.
- 95 to 1 worm gear drive and long handle provide easy engine rotation.
- Floor lock keeps stand from moving during repairs.
- Universal adapter included.
- Optional adapters available.



| MODEL NUMBER | CAPACITY | OVERALL DIMENSIONS | | | WHEEL DIAMETERS | | ROTATIONAL CLEARANCE FROM MTG. HEAD TO GROUND | SHIPPING WEIGHT |
|--------------|--------------|--------------------|-------|--------|-----------------|-------|---|-----------------|
| | | Length | Width | Height | Front | Rear | | |
| 78160 | 3 Ton | 54.25" | 50" | 45" | 7" | 5.75" | 35.25" to 43.25" | 631 lbs. |



OPTIONAL ENGINE AND TRANSMISSION MOUNTING ADAPTERS



78162: Detroit Diesel Engine Adapter for 53, 71, and 92 Series Engines.

78163: Cummins Engine Adapter for a Wide Range of Cummins Engines Including:

NH, NTC, NTE, N14 855, V6 378; 504, 555, and V8 903; In-Line 6 KT 1150M. L10 (Now ISL).

78164: Caterpillar Engine Adapter for In-Line 6 models: 1673, 1674, 1693, 3306, & 3406 engines. V8 models: 1100, 3208, and 3408.

78165: IH and Ford Engine Adapter for International Harvester engines: DT-466 In-Line 6 DV-550, MV-404, MV-446, V304, V435, V392, 4-152, 4-194, 4-196, 9.0 liter V8. Ford 6.9L and 7.3L Engines.

78166: Mack Engine Adapter for the following In-Line Six Cylinder Engine Series: 672, 673, 675, 711.

78167: Detroit Allison Transmission Adapter for AT, MT, VS, VH, and V730.

78168: Detroit Diesel Engine Adapter for V6 and V8, Series 71 Engines.

78169: Caterpillar Engine Adapter for 3114, 3116, 3176 (Truck or Marine).

78170: Mack Engine Adapter for V8 1000, E6 and E7 In-Line 6 Cylinder Engines.

78172: Volvo Engine Adapter for TD67 (developed 1964), TD71 (developed 1984) Engines.

78173: Detroit Allison Transmission Adapter for HT740D, HT750, HT750CT, CLB, CR/DR.

78174: Ford New Holland Adapter for 6.6L and 7.8L Engines.



78162
65 lbs.



78163
53 lbs.



78164
77 lbs.



78165
66 lbs.



78166
56 lbs.



78167
27 lbs.



78168
55 lbs.



78169
48 lbs.



78170
42 lbs.

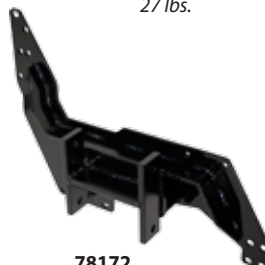

78172
50 lbs.



78173
63 lbs.



78174
63 lbs.

78013A

**12 TON CAPACITY
HAND PUMP
OPERATED**

78022D

**20 TON CAPACITY
HAND PUMP
OPERATED****INTENDED USE**

Straightening, bending & pressing.
Removing & installing gears,
bearings & bushings.

78024

**25 TON CAPACITY
AIR/HYDRAULIC
PUMP OPERATED****INTENDED USE**

Straightening, bending and
pressing. Removing and
installing gears, bearings
and bushings.

FEATURES

- Manual pump power unit with "Parkerized" pump piston, ram and extension screw to inhibit rust from entering the hydraulic system.
- Pair of bed plates included.
- Shielded heavy duty ram return springs.
- Power unit is bearing mounted for horizontal movement on head channel.
- Zero distortion, heavy duty structural steel frame.
- Optional equipment below can be used on model 78022D press. Model 78000 arbor plates and model 78032 bearing puller below can be used on model 78013A press.

**NOTE:**

Model not shown has
same basic construction
as model pictured.

78013A
(12 TON)78022D (shown)
(20 TON)**FEATURES**

- Air/hydraulic foot pump provides hands free operation.
- **Note:** See page 36 for additional information on the model 910130A pump.
- Pair of bed plates included.
- Self-retracting ram can slide for horizontal movement on head channel.
- Zero distortion, heavy duty structural steel frame.
- Liquid filled gauge measures ram force and internal working pressure.
- Optional equipment, Model 78025 Accessory Kit can be used on this press. (see below)



| MODEL NUMBER | CAPACITY | RAM TRAVEL | THROAT HEIGHT | | THROAT WIDTH | BED HEIGHT ADJUSTMENTS | BETWEEN UPRIGHTS | BETWEEN BED RAILS | BASE | | OVERALL HEIGHT | SHIPPING WEIGHT (Lbs.) |
|--------------|----------|------------|---------------|--------|--------------|------------------------|------------------|-------------------|-------|-------|----------------|------------------------|
| | | | MIN. | MAX. | | | | | WIDTH | DEPTH | | |
| 78013A | 12 Ton | 5.875" | 5" | 38.25" | 25" | 8 x 4.75" | 5" | 6" | 34" | 28" | 70.625" | 266 |
| 78022D | 20 Ton | 6.625" | 7.125" | 35.5" | 30" | 7 x 4.75" | 6" | 7" | 40" | 28" | 70.625" | 394 |
| 78024 | 25 Ton | 8" | 6.75" | 40" | 30.5" | 8 x 4.75" | 6" | 7" | 40" | 28" | 76.75" | 430 |

OPTIONAL EQUIPMENT:

78025

**ACCESSORY KIT
FOR 20 & 25
TON CAPACITY
SHOP PRESSES**

Weight: 40 lbs.

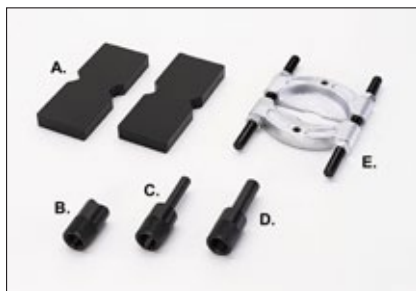
**INCLUDES:**

- A. MODEL 78033 - Arbor Plates
- B. MODEL 78028 - "V" Pushing Adapter
- C. MODEL 78029 - 3/4" Diameter Ram
- D. MODEL 78031 - 1" Diameter Ram
- E. MODEL 78032 - Bearing Puller

A.



78000

**ARBOR PLATES**

A pair of 1" x 4" x 10" long steel plates with "V" cutout on one edge and circle cutout on the other. For 12, 20 and 25 ton capacity presses only.
Weight: 20 lbs.



78021

**HYDRAULIC GAUGE
WITH FITTINGS**

4" Diameter face designed to work with NORCO 12 & 20 ton presses.
Weight: 2 lbs.



FEATURES

- Safety overload system protects power unit.
- Hand operated winch raises and lowers press bed.
- Liquid filled gauge measures ram force in pounds and tons.
- Self-retracting ram is bearing mounted for lateral movement on head channel.

The NORCO Difference:
Welded frame means no assembly required

- 78055A** (50 TON)
- 78057A** (50 TON)
- 78077** (50 TON)
- 78058A (shown)** (50 TON)
- 78078** (50 TON)
- 78110C** (100 TON)

NOTE:
Models not shown have same basic construction as model pictured.



78055A

50 TON CAPACITY HAND PUMP OPERATED

INTENDED USE
Heavy duty use in truck garages and industrial workshops.



78057A

6.25" Stroke

78077

13.25" Stroke

50 TON CAPACITY AIR/HYDRAULIC PUMP OPERATED

INTENDED USE and FEATURES

Same as model 78055A but equipped with an air/hydraulic foot pump and model 910036A 10' hose.
Note: See pages 36 & 37 for additional information on pumps.



78058A

6.25" Stroke

78078

13.25" Stroke

50 TON CAPACITY ELECTRO/HYDRAULIC PUMP OPERATED



78110C

100 TON CAPACITY ELECTRO/HYDRAULIC PUMP OPERATED

INTENDED USE and FEATURES

Same as model 78055A but the model 78058A is equipped with the model 910052A electro/hydraulic pump and the model 78110C is equipped with the model 910019B electro/hydraulic pump.
Note: See page 37 for additional information on pumps.

OPTIONAL EQUIPMENT:

78060

ACCESSORY KIT FOR 50 TON CAPACITY SHOP PRESSES

Weight: 143.5 lbs.

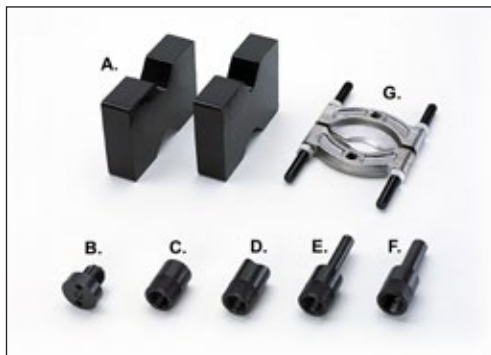

A. 78056A

50 TON CAPACITY PAIR OF ARBOR PLATES
used with all 50 ton capacity presses. Weight: 108 lbs.

78111A

100 TON CAPACITY PAIR OF ARBOR PLATES
used with model 78110C shop press. Weight: 153 lbs.

INCLUDES:

- A. MODEL 78056A - Arbor Plates
- B. MODEL 78059 - Threaded Adapter
- C. MODEL 78061 - Ram Cap
- D. MODEL 78062 - "V" Pushing Adapter
- E. MODEL 78063 - 1" Diameter Ram
- F. MODEL 78064 - 1-1/4" Diameter Ram
- G. MODEL 78066 - Bearing Puller



| MODEL NUMBER | CAPACITY | RAM TRAVEL | THROAT HEIGHT | | THROAT WIDTH | BED HEIGHT ADJUSTMENTS | BETWEEN UPRIGHTS | BETWEEN BED RAILS | BASE | | OVERALL HEIGHT | SHIPPING WEIGHT |
|---------------|----------|------------|---------------|---------|--------------|------------------------|------------------|-------------------|-------|-------|----------------|-----------------|
| | | | MIN. | MAX. | | | | | WIDTH | DEPTH | | |
| 78055A | 50 Ton | 6.25" | 7.5" | 32.625" | 34.5" | 7 x 5" | 5.625" | 7.375" | 50" | 40" | 72.75" | 804 lbs. |
| 78057A | 50 Ton | 6.25" | 7.5" | 32.625" | 34.5" | 7 x 5" | 5.625" | 7.375" | 50" | 40" | 72.75" | 801 lbs. |
| 78058A | 50 Ton | 6.25" | 7.5" | 32.625" | 34.5" | 7 x 5" | 5.625" | 7.375" | 50" | 40" | 72.75" | 814 lbs. |
| 78077 | 50 Ton | 13.25" | 7.5" | 32.625" | 34.5" | 7 x 5" | 5.625" | 7.375" | 50" | 40" | 72.75" | 833 lbs. |
| 78078 | 50 Ton | 13.25" | 7.5" | 32.625" | 34.5" | 7 x 5" | 5.625" | 7.375" | 50" | 40" | 72.75" | 846 lbs. |
| 78110C | 100 Ton | 10.25" | 18.25" | 45.75" | 40.25" | 8 x 4.5" | 5.625" | 9" | 58" | 40" | 81" | 1,777 lbs. |

BOTTLE JACKS

2, 3, 5, 8, 12, 20, 35, & 60 TON CAPACITY

INTENDED USE

For heavy duty truck, agriculture, construction, mining, mobile home, oil field, automotive, and marine applications where lifting, pushing, spreading, bending, pressing, or straightening are required.

LONG HAND JACKS

1-1/2 & 3 TON CAPACITY

INTENDED USE

Various farm applications, but primarily used as original equipment for manufacturers of shop cranes, lift tables and any equipment requiring a long hydraulic stroke.

FEATURES

- Two piece zinc plated handle.
- Prevent rust with "Parkerized" pump piston, ram and extension screw.
- No leak "Uniweld" construction.
- 50% safety overload factor.
- State-of-the-art design reduces repair time.
- Longer wear life due to internally machined oil passages, smooth bearing surfaces and close tolerances.
- Lightweight forged base provides more steel only where strength is required.
- The heavy-duty extension screw and release valve were designed to eliminate parts and reduce the chances of breakage and excessive wear.
- Safety oil by-pass system prevents the ram from being overextended and causing damage to the cylinder.

ADDITIONAL FEATURES

12 and 20 TON CAPACITY

- "G" models are designed with a removable plug so a gauge can be adapted to the jack. (See page 28 for model 78021 gauge.)

ADDITIONAL FEATURES

35 and 60 TON CAPACITY

- All other features excluding extension screw.
- A safety overload system which prevents the jack from being used beyond its rated capacity.

LONG HAND JACK FEATURES

- Same as bottle jack features but designed with larger hydraulic units and larger ram diameters to withstand side loads.
- Larger diameter pump pistons for faster rising action.
- "Parkerized" rams and flash chromed pump pistons inhibit rust.



Note: Models not shown have the same basic construction as models pictured.



| MODEL NUMBER | CAPACITY | LIFT HEIGHT | | STROKE | SCREW EXTENSION | BASE SIZE | CARRY HANDLE | SHIPPING WEIGHT |
|---------------------------------|----------------|-------------|--------|--------|-----------------|---------------|--------------|-----------------|
| | | Low | High | | | | | |
| 76502A | 2 Ton | 7.13" | 14.5" | 4.94" | 2.44" | 3.5" x 4.13" | No | 6 lbs. |
| 76503A | 3 Ton | 7.5" | 15.56" | 5.25" | 2.81" | 4" x 4.56" | No | 8 lbs. |
| 76505A | 5 Ton | 9.06" | 18.88" | 6.69" | 3.13" | 4.88" x 4.88" | No | 11.5 lbs. |
| 76508A | 8 Ton | 9.06" | 18.75" | 6.5" | 3.19" | 5.38" x 5.13" | Yes | 14 lbs. |
| 76412A 76412AG | 12 Ton | 9.45" | 18.9" | 5.91" | 3.54" | 5.51" x 5.51" | Yes | 18 lbs. |
| 76512A | 12 Ton | 6.69" | 13.19" | 3.74" | 2.76" | 5.51" x 5.51" | Yes | 15 lbs. |
| 76520A 76520AG | 20 Ton | 10.83" | 20.2" | 6.61" | 2.76" | 6.57" x 6.06" | Yes | 31 lbs. |
| 76820A | 20 Ton | 8.27" | 14.96" | 3.94" | 2.76" | 6.57" x 6.06" | Yes | 25 lbs. |
| 76535 | 35 Ton | 11" | 17.38" | 6.31" | -- | 5.63" x 7.56" | Yes | 42 lbs. |
| 76560 | 60 Ton | 12" | 18.75" | 6.69" | -- | 7.44" x 9.31" | Yes | 82 lbs. |
| LONG HAND JACKS | | | | | | | | |
| 76402A | 1.5 Ton | 22.6" | 41.9" | 19.3" | -- | 4.05" x 4.57" | No | 17.5 lbs. |
| 76403A | 3 Ton | 24" | 43.5" | 19.5" | -- | 4.88" x 4.40" | No | 24 lbs. |

The NORCO Difference:
More quality features in a unique design

NORCO AIR OPERATED HYDRAULIC BOTTLE JACKS

FEATURES

- Fast efficient air pump reduces lifting time and has a built-in relief mechanism which prevents the jack from being used beyond its maximum capacity.
- Convenient push button air valve connected to an in-line filter prevents contaminants from entering the air/hydraulic system.
- Unique design allows for manual operation when air is not available.
- Two piece zinc plated handle.
- Parkerized coating on pump piston, extension screw and extension adapters and chrome coated ram offer protection against rust.
- Longer wear life due to internally machined oil passages, smooth bearing surfaces and close tolerances.
- Safety oil by-pass system prevents the ram from being overextended and causing damage to the cylinder.
- Carrying handle.



**Note: Models not shown have the same basic construction as models pictured.*

76312A (shown)
***76320A**
***76720A**

76312A

12 TON CAPACITY STANDARD HEIGHT

76320A

20 TON CAPACITY STANDARD HEIGHT

76720A

20 TON CAPACITY LOW HEIGHT

INTENDED USE

For use in heavy duty trucks, farm equipment, building construction, construction and mining equipment, mobile home set-up and oil field applications.



| MODEL NUMBER | CAPACITY | LIFT HEIGHT | | STROKE | SCREW EXTENSION | BASE SIZE | P.S.I. RANGE | SHIPPING WEIGHT |
|---------------|---------------|-------------|--------|--------|-----------------|--------------|--------------|-----------------|
| | | Low | High | | | | | |
| 76312A | 12 Ton | 9.63" | 19.75" | 6" | 4" | 6.63" x 8" | 100-130 | 24 lbs. |
| 76320A | 20 Ton | 10.88" | 20.5" | 6.75" | 2.75" | 7.5" x 9.25" | 100-130 | 41 lbs. |
| 76720A | 20 Ton | 8.25" | 14.5" | 4" | 2.25" | 7.5" x 9.25" | 100-130 | 34 lbs. |

The NORCO Difference:
Portable lifting for professional or DIY

NORCO PORTABLE MID-RISE LIFT

FEATURES

- Portable trolley supports the pump and maneuvers the lift from one service bay to another.
- Twin hydraulic cylinders and scissors lift design provide maximum support and stability.
- Hydraulic velocity fuses allow slow release of lift in the event of hose or hydraulic component damage.
- 4-1/2" low height for easy drive on and off.
- Fast and efficient operating pump powered by a 1 hp, 115 volt motor (1 year warranty on pump and motor).
- Sliding radius arms easily adjust to vehicle frame lift positions.
- Automatic mechanical safety lock will lock in a 24-1/2", 31", 36-3/4", 42-1/8", 46-1/2", 50-3/4", or 55" lift height.
- 12' hydraulic hose & 12-1/2' release cable.



86002A

55" MID-RISE LIFT 6,000 LBS. CAPACITY

INTENDED USE

Lifts cars, vans and light-duty trucks for wheel and brake related repairs, tire and wheel changing, collision repair work and new car preparation.

86010A

EXTENSION ADAPTERS

For higher frame clearance vehicles. Includes four 4-1/2" extension adapters for use with swivel rubber lifting pads included with the 86002A. Weight: 18 lbs.



| MODEL NUMBER | CAPACITY | OVERALL DIMENSIONS | | LIFT HEIGHT | | SHIPPING WEIGHT |
|---------------|-------------------|--------------------|--------|-------------|------|-----------------|
| | | Length | Width | Low | High | |
| 86002A | 6,000 lbs. | 96.5" | 39.75" | 5.5" | 55" | 965 lbs. |

**904004B****4 TON CAPACITY KIT
(FORGED ADAPTERS)****904005A****4 TON CAPACITY KIT
(CAST ADAPTERS)****INTENDED USE**

For collision repair, industrial and construction applications where convenience of hydraulic power can be utilized for spreading, clamping, pushing and lifting operations.

NOTE: Cast & forged adapter components vary in size and are not interchangeable.

FEATURES

- "Quick-Lock" design for fast and easy assembly and disassembly.
- Long handle provides ease of pumping.
- Thick walled extension tubes for added strength and longer life.
- Roto-molded plastic case for organized component storage and ease of carrying.
- Flexible hydraulic hose with spring guards at both ends.
- Forged steel adapters for added strength and durability (904004B/910005B).
- All casting parts are made of nodular cast iron (904005A/910006A).

Kit Weight:

904004B: 41 lbs.

904005A: 42 lbs.

**4 TON kits include:**

- PLASTIC CASE
- 10,000 P.S.I. PUMP
- 6' HOSE
- 4" STROKE RAM
- WEDGE RAM (1/2 TON CAP.)
- 4", 8", 12" AND 16" EXTENSION TUBES
- TUBE CONNECTOR
- SERRATED SADDLE
- RUBBER HEAD
- WEDGE HEAD
- RAM TOE
- PLUNGER TOE
- RUBBER FACED FLAT BASE
- 90 DEGREE "V" BASE

904004B (shown)***904005A**

(4 TON)

910005B**10 TON CAPACITY KIT
(FORGED ADAPTERS)****910006A****10 TON CAPACITY KIT
(CAST ADAPTERS)****INTENDED USE**

Same as 4 ton kits but for heavier jobs such as automotive frame straightening.

NOTE: Cast & forged adapter components vary in size and are not interchangeable.

FEATURES

- All the same features found in the 4 ton kits.

Kit Weight:

910005B: 83 lbs.

910006A: 77 lbs.

**10 TON kits include:**

- WHEELED PLASTIC CASE
- 10,000 P.S.I. PUMP
- 6' HOSE
- 6" STROKE RAM
- WEDGE RAM (1/2 TON CAP.)
- 5", 10", 14" AND 19" EXTENSION TUBES
- TUBE CONNECTOR
- SERRATED SADDLE
- RUBBER HEAD
- WEDGE HEAD
- 90 DEGREE "V" BASE
- FLAT BASE
- RAM TOE
- PLUNGER TOE

910005B (shown)***910006A**

(10 TON)

920020**20 TON CAPACITY KIT
(FORGED ADAPTERS)****INTENDED USE**

A deluxe kit for repairing heavy road machinery, trucks, farm equipment and also used for some heavy construction applications.

MODEL 920020 KIT includes:

- STEEL CASE (1 OF 2)
- 2-SPEED PUMP
- 5' HOSE
- RAM, 5" STROKE
- 3-1/2" DIA. SADDLE (2)
- THREADED COUPLER (3)
- TOE LIFT
- WEDGE HEAD
- VEE HEAD
- STEEL CASE (2 OF 2)
- 3" EXTENSION TUBE (2)
- 5" EXTENSION TUBE
- 10" EXTENSION TUBE
- 20" EXTENSION TUBE
- 27-1/2" EXTENSION TUBE
- 6-1/2" DIA. BASE (2)

FEATURES

- Two steel cases with carrying handles share the weight for easier handling of kit.
- Two-speed pump quickly raises ram to load and secondary pump provides powerstroke.

Kit Weight: 152 lbs.

FEATURES

- Heavy duty rubber hoses rated at 10,000 P.S.I. meet IJ-100 specifications. Hoses are rubber coated with 2 layers of braided steel and offer flexibility with little memory. Strain relief type fittings are crimped on for improved life and durability.
- Quick connect 3/8" high flow couplers allow fast set-up of hydraulic systems. All couplers include two-in-one dust cap for use on male and female coupler halves.

HOSES AND COUPLERS

INTENDED USE

These heavy duty hoses and couplers are used to join pumps and cylinders together (see pages 34-37).



| MODEL NUMBER | DESCRIPTION | CAPACITY | HOSE OR COUPLER I.D. | CONNECTION | WEIGHT |
|----------------|------------------------|----------------------|----------------------|-------------------------|----------|
| 910035A | 6.5' Long Hose | 10,000 P.S.I. | .375" | .375 NPT Male Both Ends | 4.5 lbs. |
| 910036A | 10' Long Hose | 10,000 P.S.I. | .375" | .375 NPT Male Both Ends | 7 lbs. |
| 910037A | Coupler, Hose Half | 10,000 P.S.I. | .375" | .375 NPT Male End | 1 lbs. |
| 910038A | Coupler, Cylinder Half | 10,000 P.S.I. | .375" | .375 NPT Female End | 1 lbs. |

910043A & 925142A

Heavy duty bases provide firmer and more stable footing for cylinders.

910044A & 925143A

Threaded male connectors adapt bases to the cylinders.

910046A & 925141A

Grooved saddles protect the cylinder ends and provide a better gripping surface.

BASES, SADDLES & ATTACHMENTS

910048 & 925148

Threaded adapters screw into the tops of the cylinders and provide a threaded connection for other attachments.

910039 & 925045

Base attachments are bolted to the bottom of the cylinders and are internally threaded to receive other attachments.



| MODEL NUMBER | DESCRIPTION | CAPACITY | FOR USE ON CYLINDERS | CONNECTION (NPT) | WEIGHT |
|----------------|----------------------------|-------------------|----------------------|--------------------|----------|
| 910043A | 3.5" x 6.5" Base | 5 Ton | 10 Ton Cap. | 1.25 x 11.5 Female | 3.5 lbs. |
| 925142A | 6.5" Dia. Base | 12-1/2 Ton | 25 Ton Cap. | 2 x 11.5 Female | 9.5 lbs. |
| 910044A | Male Connector | 5 Ton | 10 Ton Cap. | 1.25 x 11.5 Male | 0.5 lbs. |
| 925143A | Male Connector | 12-1/2 Ton | 25 Ton Cap. | 2 x 11.5 Male | 4.5 lbs. |
| 910046A | 1.375" Dia. Grooved Saddle | 10 Ton | 10 & 15 Ton Cap. | — | 0.5 lbs. |
| 925141A | 2" Dia. Grooved Saddle | 25 Ton | 25 Ton Cap. | — | 0.5 lbs. |
| 910048 | Threaded Adapter | 5 Ton | 10 & 15 Ton Cap. | 1.25 x 11.5 Male | 1 lbs. |
| 925148 | Threaded Adapter | 12-1/2 Ton | 25 Ton Cap. | 2 x 11.5 Male | 2.5 lbs. |
| 910039 | Base Attachment | 5 Ton | 10 Ton Cap. | 1.25 x 11.5 Female | 2 lbs. |
| 925045 | Base Attachment | 12-1/2 Ton | 25 Ton Cap. | 2 x 11.5 Female | 5.5 lbs. |

MAX. 50% CAUTION! When cylinders are used with maintenance set attachments or components, the maximum system pressure must be limited to half the rated pressure (5,000 P.S.I.).



910100B

FLOW CONTROL VALVE

Manually adjusted fine metering valve rated at 10,000 P.S.I. that fits between the pump and cylinder. The valve controls the flow of oil returning to the reservoir when pressure is released. Valve includes 3/8" NPTF male and female connections. Weight: 1 lb.

CYLINDERS

INTENDED USE

For many applications including shop, agricultural, automotive / truck service needs and construction maintenance applications where lifting, pushing, pulling, bending or holding may be required.



NOTE:
Models not shown have same basic construction as model pictured.



910028A Wedge Ram
910027A
910026A (shown)
910029A
910030
910047
915006
925026B
925023
925024 (shown)
925025A
925027A
910010 (shown)
930008
955106
999106
930003
950005
955019A (shown)
999000

SINGLE-ACTING CYLINDER FEATURES

- High flow quick connecting coupler and dust cap included on all models.
- Unique piston and cylinder bearings absorb eccentric load stresses in order to protect the cylinder against abrasion, over-extending and jamming.
- Nickel plating on most cylinder pistons inhibits rusting.
- Baked enamel exterior finish for increased corrosion resistance.
- Polyurethane seals and wipers provide high cycle life.
- Heavy duty return springs provide consistent performance.
- Cylinders comply with ANSI B 30.1.

DOUBLE-ACTING CYLINDER FEATURES

- Same as the standard cylinders but have the ability to pull as well as push under power.
- IMPORTANT: Double-acting cylinders can only be used with the 4-way valve hand pump model 925014 found on page 37.
- Built-in safety valve prevents over-pressurization.

910028A

WEDGE RAM FEATURES

- Jaws open from 3/8" to 3-11/16" so ram can be used in very confined work areas.
- Spring retractable jaws.

SINGLE-ACTING CYLINDERS

| MODEL NUMBER | CAPACITY | STROKE (Inches) | OIL CAP (Cu. In.) | CYLINDER BORE DIA. (Inches) | CYLINDER EFFECTIVE AREA(Sq.In.) | RETURN SPRING | HEIGHT | | OUTSIDE DIA. | | THREAD SIZE | | | SHIPPING WEIGHT |
|--------------|----------|-----------------|-------------------|-----------------------------|---------------------------------|---------------|--------|--------|--------------|----------|--------------|------------------------------|---------------------|-----------------|
| | | | | | | | Min. | Max. | Piston | Cylinder | Piston (NPT) | CYL. COLLAR (Inches x Thrd.) | INTERNAL BASE (NPT) | |
| 910026A | 10 Ton | 6.13 | 13.67 | 1.69 | 2.23 | YES | 12.5" | 18.63" | 1.5" | 2.25" | 1.25 x 11.5 | 2.25 x 14 | 1.25 x 11.5 | 10 lbs. |
| 910027A | 10 Ton | 2.13 | 4.75 | 1.69 | 2.23 | YES | 4.5" | 6.63" | 1.5" | 2.25" | --- | 2.25 x 14 | --- | 6 lbs. |
| 910029A | 10 Ton | 10.13 | 22.59 | 1.69 | 2.23 | YES | 16.5" | 26.63" | 1.5" | 2.25" | 1.25 x 11.5 | 2.25 x 14 | 1.25 x 11.5 | 14 lbs. |
| 910030 | 10 Ton | 12 | 26.76 | 1.69 | 2.23 | YES | 15.75" | 27.75" | 1.5" | 2.25" | --- | 2.25 x 14 | --- | 16.5 lbs. |
| 910047 | 10 Ton | 14 | 31.22 | 1.69 | 2.23 | YES | 17.75" | 31.75" | 1.5" | 2.25" | --- | 2.25 x 14 | --- | 18 lbs. |
| 915006 | 15 Ton | 6 | 18.84 | 2.00 | 3.14 | YES | 10.69" | 16.69" | 1.63" | 2.75" | --- | 2.75 x 16 | --- | 15 lbs. |
| 925026B | 20 Ton | 1.75 | 7.77 | 2.38 | 4.44 | YES | 3.88" | 5.63" | 2.00" | 3.63" | --- | --- | --- | 11 lbs. |
| 925023 | 25 Ton | 4 | 20.60 | 2.56 | 5.15 | YES | 8.5" | 12.5" | 2.25" | 3.38" | --- | 3.31 x 12 | --- | 18 lbs. |
| 925024 | 25 Ton | 10.25 | 52.79 | 2.56 | 5.15 | YES | 14.75" | 25" | 2.25" | 3.38" | --- | 3.31 x 12 | --- | 31 lbs. |
| 925025A | 25 Ton | 6.25 | 32.19 | 2.56 | 5.15 | YES | 14.88" | 21.13" | 2.25" | 3.38" | 2 x 11.5 | 3.31 x 12 | 2 x 11.5 | 22 lbs. |
| 925027A | 25 Ton | 14.25 | 73.39 | 2.56 | 5.15 | YES | 22.88" | 37.13" | 2.25" | 3.38" | 2 x 11.5 | 3.31 x 12 | 2 x 11.5 | 39 lbs. |
| 930003 | 30 Ton | 2.44 | 15.85 | 2.88 | 6.50 | YES | 4.63" | 7.06" | 2.62" | 4.00" | --- | --- | --- | 15 lbs. |
| 950005 | 50 Ton | 2.38 | 22.91 | 3.50 | 9.63 | YES | 4.81" | 7.19" | 2.75" | 5.00" | --- | --- | --- | 24 lbs. |
| 955019A | 50 Ton | 6.25 | 69.06 | 3.75 | 11.05 | YES | 11.13" | 17.38" | 3.13" | 5.00" | --- | 5 x 12 | --- | 51 lbs. |
| 999000 | 100 Ton | 10.25 | 211.66 | 5.13 | 20.65 | YES | 17.69" | 27.94" | 4.13" | 7.00" | --- | 6.89 x 12 | --- | 160 lbs. |

DOUBLE-ACTING CYLINDERS

| MODEL NUMBER | CAPACITY (Tons) | | STROKE (Inches) | OIL CAP (Cu. In.) | | CYLINDER BORE DIA. (Inches) | CYLINDER EFFECTIVE AREA(Sq.In.) | | HEIGHT | | OUTSIDE DIA. | | SADDLE DIAMETER | COLLAR THREAD SIZE | SHIPPING WEIGHT |
|--------------|-----------------|------|-----------------|-------------------|-------|-----------------------------|---------------------------------|------|---------|--------|--------------|----------|-----------------|--------------------|-----------------|
| | Push | Pull | | Push | Pull | | Push | Pull | Min. | Max. | Piston | Cylinder | | | |
| 910010 | 10 | 4 | 10 | 22.33 | 8.00 | 1.69 | 2.23 | .80 | 16.125" | 26.13" | 1.38" | 2.88" | 1.38" | 2.25 x 14 | 28 lbs. |
| 930008 | 30 | 5 | 8.25 | 53.67 | 25.00 | 2.88 | 6.51 | 3.00 | 15.25" | 23.5" | 2.13" | 4.00" | 2" | 3.31 x 12 | 40 lbs. |
| 955106 | 50 | 10 | 6.125 | 67.77 | 21.00 | 3.75 | 11.06 | 3.40 | 13.06" | 19.19" | 3.13" | 5.00" | 2.81" | 5 x 12 | 67 lbs. |
| 999106 | 100 | 48 | 6.625 | 136.93 | 63.00 | 5.13 | 20.65 | 9.60 | 14.06" | 20.69" | 3.75" | 7.00" | 3" | 6.88 x 12 | 135 lbs. |

WEDGE RAM

| MODEL NUMBER | CAPACITY | ARM HEIGHT | | OVERALL DIMENSIONS | | | CYLINDER AREA (Cu.In.) | OIL CAP (Cu.In.) | SHIPPING WEIGHT |
|--------------|----------|------------|-------|--------------------|-------|--------|------------------------|------------------|-----------------|
| | | CLOSED | OPEN | HEIGHT | WIDTH | LENGTH | | | |
| 910028A | 1 Ton | .38" | 3.69" | 2.01" | 2.01" | 8.78" | 1.00 | .61 | 5 lbs. |



FEATURES

- Lightweight aluminum body.
- Extremely durable.
- Ships completely assembled with coupler, shutoff, and base.
- The perfect cylinder for heavy-duty road service.
- These portable cylinders lift 50 tons with 10,000 P.S.I. hydraulic pumps.

955055

50 TON ALUMINUM RAM w/ BASE & SHUTOFF VALVE

INTENDED USE

Made for lifting heavy off-road and construction equipment.



| MODEL NUMBER | CAPACITY | STROKE (Inches) | OIL CAP (Cu. In.) | CYLINDER BORE DIA. (Inches) | CYLINDER EFFECTIVE AREA(Sq.In.) | RETURN SPRING | HEIGHT | | OUTSIDE DIA. | | SHIPPING WEIGHT |
|---------------|---------------|-----------------|-------------------|-----------------------------|---------------------------------|---------------|--------|------|--------------|----------|-----------------|
| | | | | | | | Min. | Max. | Piston | Cylinder | |
| 955055 | 50 Ton | 6.25 | 69 | 3.75 | 11.05 | YES | 11.75" | 18" | 3.13" | 6" | 39 lbs. |

COMPATIBILITY CHART
HYDRAULIC CYLINDERS (Page 34)

| PUMPS (Pages 36-37) | 910010 | 910028A | 910027A | 910028A | 910029A | 910030 | 910047 | 915006 | 925023 | 925024 | 925025A | 925028B | 925027A | 930003 | 930008 | 950005 | 955019A | 955055 | 955070 | 955106 | 999000 | 999106 | |
|------------------------|--------|---------|---------|---------|---------|--------|--------|--------|--------|--------|---------|---------|---------|--------|--------|--------|---------|--------|--------|--------|--------|--------|--|
| 910017B | | ● | ● | ● | ● | ● | ● | ● | ● | ● | ● | ● | ● | ● | | ● | ● | ● | ● | | | | |
| 910018B | | ● | ● | ● | ● | ● | ● | ● | ● | ● | ● | ● | ● | ● | | ● | ● | ● | ● | | ● | | |
| 910019B | | ● | ● | ● | ● | ● | ● | ● | ● | ● | ● | ● | ● | ● | | ● | ● | ● | ● | | ● | | |
| 910020 | | ● | ● | ● | ● | ● | ● | ● | ● | | ● | | | ● | | | | ● | | | | | |
| 910052A | | ● | ● | ● | ● | ● | ● | ● | ● | ● | ● | ● | ● | ● | | ● | ● | ● | ● | | | | |
| 910130A | | ● | ● | ● | ● | ● | ● | ● | ● | ● | ● | ● | ● | ● | | ● | ● | ● | ● | | ● | | |
| 910140 | | ● | ● | ● | ● | ● | ● | ● | ● | ● | ● | ● | ● | ● | | ● | ● | ● | ● | | ● | | |
| 925009A | | ● | ● | ● | | | | | | | | ● | | ● | | | | | | | | | |
| 925010A | | ● | ● | ● | ● | ● | ● | ● | ● | | ● | ● | | ● | | ● | | ● | ● | | | | |
| 925011 | | ● | ● | ● | ● | ● | ● | ● | ● | | ● | ● | | ● | | ● | | ● | ● | | | | |
| 925012A | | ● | ● | ● | ● | ● | ● | ● | ● | ● | ● | ● | ● | ● | | ● | | ● | ● | | | | |
| 925013B | | ● | ● | ● | ● | ● | ● | ● | ● | ● | ● | ● | ● | ● | | ● | ● | ● | ● | | | | |
| 925014 | ● | | | | | | | | | | | | | | ● | | | | | ● | | ● | |

Note: A dot inside a square indicates there is sufficient oil in the pump to operate the cylinder to maximum extension. Although some pumps and cylinders are compatible, the useable oil capacity in both are so close that longer hoses (requiring more oil) that connect both components may prevent the pump from operating the cylinder to maximum extension.

910017B 910018B
910130A 910140

10,000 P.S.I. CAPACITY

INTENDED USE

For automotive / truck, industrial & construction jobs. The added convenience of an air motor reduces pumping time and effort to activate cylinders.



910017B



910018B

FEATURES

- Designed to utilize exhaust air to help power the pump, requiring only 80 P.S.I. air pressure to develop 10,000 P.S.I. hydraulic pressure.
- Air exhaust muffler for quieter operation.
- Air and oil inlet filters for reduced risk of damage from contamination.
- Designed with durable light weight, corrosion resistant plastics.
- Foot pedal provides hands free pumping and release of load.
- Designed to be used with a single-acting cylinder.
- Internal pressure relief valve for overload protection.
- Model 910018B has two-gallon capacity steel reservoir body.



910130A



910140

FEATURES

Same as the models 910017B and 910018B but with added features:

- The model 910130A pump is equipped with a more durable aluminum reservoir.
- Both models 910130A and 910140 come with two different size poppit valves that can be quickly and easily installed. Poppit valves reduce the return flow of oil back to the pump's reservoir providing a safer controlled lowering of load.
- The model 910140 pump is equipped with a thick wall aluminum extruded reservoir.

910020

3,250 P.S.I. CAPACITY

INTENDED USE

Same as the model 910017B, but with a steel reservoir body, a manually activated push button for pumping and a lever for release of load. The pump operates in all positions for increased versatility in use and mounting.



| MODEL NUMBER | HYDRAULIC PRESSURE RATING (P.S.I.) | USABLE OIL CAP. (Cu. In.) | OUTPUT FLOW RATE (Cu. In. Per Min.) | | AIR PRESSURE RANGE (P.S.I.) | AIR CONSUMPTION (scfm) | VALVE FUNCTION | SOUND LEVEL (dBA) | THREAD CONNECTIONS | | DIMENSIONS (Inches) | | | WEIGHT (Lbs.) |
|----------------|------------------------------------|---------------------------|-------------------------------------|------|-----------------------------|------------------------|------------------------|-------------------|--------------------|-----------------|---------------------|-------|--------|---------------|
| | | | No Load | Load | | | | | AIR (NPT) | HYDRAULIC (NPT) | Length | Width | Height | |
| 910017B | 10,000 | 127 | 60 | 10 | 25-125 | 12 | Advance / Hold Retract | 76 | .25"-18 | .375"-18 | 13.63" | 6.19" | 8.19" | 14 |
| 910018B | 10,000 | 462 | 60 | 10 | 25-125 | 12 | Advance / Hold Retract | 76 | .25"-18 | .375"-18 | 13.63" | 12" | 11.38" | 38 |
| 910020 | 3,250 | 36 | 40 | 8 | 60-120 | 9 | Advance / Hold Retract | 85 | .25"-18 | .125"-27 | 15.5" | 4.5" | 5" | 9 |
| 910130A | 10,000 | 122 | 80.5 | 12.8 | 40-170 | 24 | Advance / Hold Retract | 85 | .25"-18 | .375"-18 | 12.5" | 5.75" | 8" | 22 |
| 910140 | 10,000 | 462 | 80.5 | 12.8 | 40-170 | 24 | Advance / Hold Retract | 85 | .25"-18 | .375"-18 | 14" | 8.5" | 10.75" | 44 |

The NORCO Difference:
Portable and durable high performance

STEEL HAND PUMP FEATURES

925009A, 925010A, & 925013B

- 3/8 NPT hose connection on all pumps.
- Internal pressure relief valves for overload protection.
- External load release valve for single-acting cylinder operation.
- Two-speed pump operation on model 925013B for reduced operator fatigue.

LIGHTWEIGHT HAND PUMP FEATURES

925011, 925012A, & 925014

Same as for the steel hand pumps but with the following additions:

- Durable glass-filled nylon reservoir and nylon encapsulated aluminum pump base for maximum corrosion resistance and lightweight handling.
- Two-speed pump operation on models 925011 and 925014 reduces handle strokes by as much as 78% over single speed pumps.
- Integral 4-way valve on the model 925014 for operation of double-acting cylinders.
- Handle lock for easy carrying.
- Non-conductive fiberglass handle for operator safety.



HAND PUMPS

INTENDED USE

For many applications including shop, agricultural, automotive/truck service needs and construction maintenance applications where high pressure pumps are required to activate cylinders rated as high as 55 ton capacity.

NOTE:
Models not shown have same basic construction as model pictured.



| PUMP TYPE | | | | MODEL NUMBER | PRESSURE RATING (P.S.I.) | | USABLE OIL CAP. (Cu. In.) | OIL DISPLACEMENT PER STROKE (Cu. In.) | | MAXIMUM HANDLE EFFORT (Lbs.) | PISTON STROKE (In.) | DIMENSIONS (Inches) | | | PUMP HANDLE ARC | WEIGHT (Lbs.) |
|--------------|-----------|-------|--------------|--------------|--------------------------|------------|---------------------------|---------------------------------------|------------|------------------------------|---------------------|---------------------|-------|--------|-----------------|---------------|
| Single Speed | Two Speed | Steel | Light Weight | | 1st. Stage | 2nd. Stage | | 1st. Stage | 2nd. Stage | | | Length | Width | Height | | |
| ● | | ● | | 925009A | 2,850 | — | 18 | .16 | — | 57 | .81 | 13.38 | 5.25 | 5.25 | 40° | 11 |
| ● | | ● | | 925010A | 10,000 | — | 40 | .16 | — | 111 | .81 | 23 | 5.25 | 5.25 | 40° | 13 |
| | ● | | ● | 925011 | 200 | 10,000 | 55 | .687 | .151 | 93 | 1.00 | 21.63 | 4.75 | 7 | 50° | 9 |
| ● | | | ● | 925012A | 10,000 | — | 55 | .151 | — | 85 | 1.00 | 21.63 | 4.75 | 7 | 50° | 9 |
| | ● | ● | | 925013B | 350 | 10,000 | 134 | .99 | .15 | 104 | 1.00 | 22.5 | 5.75 | 7 | 50° | 24 |
| | ● | | ● | 925014 | 400 | 10,000 | 155 | 2.40 | .151 | 95 | 1.00 | 21.75 | 4.75 | 9 | 50° | 22 |

The NORCO Difference:
Best in class

910019B

FEATURES

- Two-speed design reduces cycle times for improved productivity.
- Single-phase 115 VAC, 1 hp induction motor will start at full load and stand up to continuous duty applications. Requires a steady power supply.
- 10 foot pendant controls the motor operation.
- Manual advance/retract valve control for single-acting cylinders.
- LCD display provides a number of diagnostic and readout capabilities.



910052A

910052A

FEATURES

- Lightweight and compact design.
- High strength molded shroud with integral easy-carry handle protects motor from contamination.
- 115 VAC, 1/2 hp motor operates on voltages as low as 60 volts.
- 10 foot pendant for operator safety.
- Two-speed motor design with 3-way 2-position valve for use with single-acting cylinders.



910019B

910019B and 910052A

10,000 P.S.I. CAPACITY

INTENDED USE

Same as for the air/hydraulic pumps but will handle single-acting cylinders up to 100 ton. The added convenience of an electro-hydraulic pump reduces pumping time and effort.

NOTE: All electrical motors are warranted against defects in material and workmanship for one year from the date of end user's purchase.



| MODEL NUMBER | HYDRAULIC PRESSURE RATING (P.S.I.) | | USABLE OIL CAP. (Cu. In.) | OUTPUT FLOW RATE (Cu. In. Per Min.) | | CURRENT DRAW (Amps.) | MOTOR VOLTAGE (VAC) | SOUND LEVEL (dBA) | THREAD CONNECTION (NPT) | VALVE TYPE | DIMENSIONS (Inches) | | | WEIGHT (Lbs.) |
|--------------|------------------------------------|------------|---------------------------|-------------------------------------|------------|----------------------|---------------------|-------------------|-------------------------|------------------------|---------------------|-------|--------|---------------|
| | 1st. Stage | 2nd. Stage | | 1st. Stage | 2nd. Stage | | | | | | Length | Width | Height | |
| 910019B | 450 | 10,000 | 462 | 400 | 40 | 20 | 115 | 75 | .375"-18 | Advance / Retract | 19 | 9.75 | 23 | 73 |
| 910052A | 200 | 10,000 | 238 | 200 | 20 | 9.5 | 115 | 85 | .375"-18 | Advance / Hold Retract | 14.5 | 12.25 | 14.75 | 31 |

A NATIONAL NETWORK OF AUTHORIZED SERVICE CENTERS PROVIDE PROFESSIONAL NORCO SERVICE AND REPAIR

LIMITED LIFETIME WARRANTY *Effective: February 25, 2010*

NORCO Professional Lifting Equipment's products and parts¹ are warranted against defects in materials and workmanship for the life of the product or the part.

This warranty is expressly limited to persons who purchase NORCO products or parts for the purpose of resale or use in the ordinary course of the buyer's business.

This warranty does not cover any product or part that has been abused, misused, worn out, neglected, ground or otherwise altered, used for a purpose other than for which it was intended, or used in a manner inconsistent with any instructions regarding its use. In addition, this warranty does not cover any chains, batteries or electric motors, which are sold with NORCO products. All electric motors are separately warranted by their manufacturer under the conditions stated in the separate warranty.

THIS WARRANTY IS EXCLUSIVE AND NORCO MAKES NO OTHER WARRANTY OF ANY KIND WHATSOEVER, EXPRESS OR IMPLIED, WITH RESPECT TO THE SPECIFIED PRODUCTS OR PARTS MANUFACTURED AND/OR SOLD BY IT, INCLUDING, BUT NOT LIMITED TO, IMPLIED WARRANTIES OF MERCHANTABILITY OR FITNESS FOR A PARTICULAR PURPOSE OR ANY OTHER MATTER. No agent, employee or representative of NORCO, or any other person, has authority to bind NORCO to any affirmation, representation or warranty concerning NORCO products or parts except as set forth herein.

If any NORCO product or part is determined by NORCO, in its sole judgment, to be defective, NORCO will, at its option, either repair or replace such defective product or part. THIS REMEDY SHALL BE THE EXCLUSIVE REMEDY AVAILABLE FOR ANY DEFECTIVE NORCO PRODUCT OR PART AND FOR ALL DAMAGES RESULTING FROM ANY CAUSE WHATSOEVER, INCLUDING, WITHOUT LIMITATION, NORCO'S NEGLIGENCE. IN NO EVENT SHALL NORCO BE LIABLE TO ANY BUYER OR OTHER PERSON FOR CONSEQUENTIAL OR INCIDENTAL DAMAGES OF ANY KIND OR NATURE WHATSOEVER, WHETHER FOR DEFECTIVE OR NONCONFORMING GOODS, OR UNDER ANY THEORY OF LIABILITY, INCLUDING, BUT NOT LIMITED TO, BREACH OF CONTRACT (EXPRESS OR IMPLIED), NEGLIGENCE, STRICT LIABILITY OR OTHERWISE. The purpose of this exclusive remedy shall be to provide the buyer with repair or replacement of NORCO products or parts determined by NORCO to be defective in material or workmanship. This exclusive remedy shall not be deemed to have failed of its essential purpose so long as NORCO is willing and able to repair or replace said defective product or part in the prescribed manner.

¹ Excludes equipment and part numbers as noted in the NORCO Professional Lifting Equipment catalog or other literature, which have a separate Limited One-Year Warranty.

NORCO's four distribution centers ensure quick delivery across North America.

